

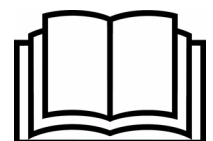

Portable Power

G10, G20, G30, G40, G60, G80, G100, G160, G200, G250, G400, G500 OPERATION & MAINTENANCE MANUAL

EN

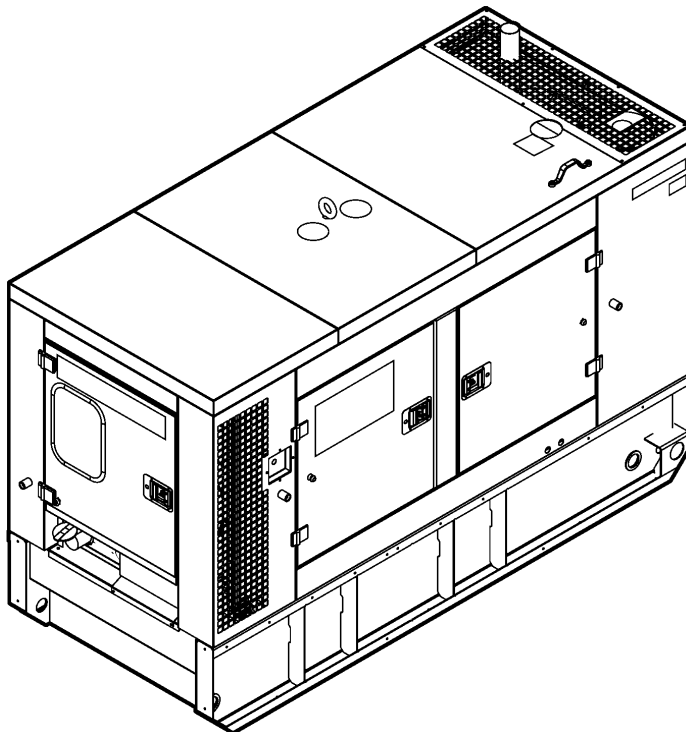



Portable Power

TABLE OF CONTENTS

Operation & Maintenance Manual

TITLE	PAGE
FOREWORD	5
SAFETY SYMBOLS	7
SAFETY	11
HAZARDOUS SUBSTANCE PRECAUTION	16
GENERAL DATA	17
OPERATING INSTRUCTIONS	21
BEFORE STARTING	22
STARTING	23
STOPPING	24
REMOTE STARTING AND STOPPING	24
DIAGNOSTICS/AUTO SHUTDOWN	24
ENGINE CONTROLS and INSTRUMENTS	25
GENERATOR SYSTEM	27
MONITOR SWITCHES	27
PROTECTION/REGULATION	28
STARTING (KEY START MODELS)	29
STOPPING (KEYSTART MODELS)	30
DIAGNOSTICS/AUTO SHUTDOWN (KEYSTART MODELS)	31
GENERATOR SYSTEM (KEYSTART MODELS)	32
MONITOR SWITCHES	32
CIRCUIT BREAKERS - Flip to Reset (if equipped)	32
SOCKETS (if equipped)	32
PROTECTION/REGULATION	33
BASIC DIGITAL CONTROLS OPERATION	34
MAINTENANCE	49
General	50
Scheduled Maintenance	50
ADJUSTMENT INSTRUCTIONS and TESTING PROCEDURES	56
VOLTAGE REGULATOR ADJUSTMENT	57
POWER BYPASS SWITCH FOR ENGINE ECU SERVICE	58
ALTERNATOR INSTALLATION AND MAINTENANCE	59
SAFETY MEASURES	60
INSTALLATION - COMMISSIONING	66
SERVICING-MAINTENANCE	70
TECHNICAL CHARACTERISTICS	76

*****Always use Doosan Replacement parts!*****



Foreword



SAMPLE



²¹ **EC Declaration of Conformity**

²¹ Original declaration

³¹ **We:**

Doosan International USA, Inc
1293 Glenway Drive
Statesville
North Carolina 28625-9218
USA

⁴¹ **Represented in EC by:**

Doosan Trading Limited
Block B, Swords Business Campus
Swords
Co. Dublin
Ireland

⁵¹ **Hereby declare that, under our sole responsibility the product(s)**

- ⁶¹ Machine description: Portable Generator
- ⁷¹ Machine Model: G10, G20, G30, G40, G60, G80, G100, G150, G200, G250, G400, G500
- ⁸¹ Commercial name: G10, G20, G30, G40, G60, G80, G100, G150, G200, G250, G400, G500
- ⁹¹ Serial number:

¹⁰¹ **is (are) in conformity with the relevant provisions of the following EC Directive(s)**

- ¹¹¹ 2006/42/EC The Machinery Directive
- ¹²¹ 2004/108/EC The Electromagnetic Compatibility Directive
- ¹³¹ 2000/14/EC The Noise Emission Directive
- ¹⁶¹ 97/68/EC The emission of engines for no-road mobile machinery
- ²¹¹ 2006/95/EC The Low Voltage Equipment Directive
- ¹⁷¹ and their amendments

¹⁸¹ **Conformity with the Noise Emission Directive 2000/14/EC**

¹⁹¹ Directive 2000/14/EC, Annex VI, Part I							
²⁰¹ Notified body: AV Technology, Stockport, UK. Nr 1067							
²¹¹ Machine		²²¹ Measured sound power level	²³¹ Guaranteed sound power level	²¹¹ Machine		²²¹ Measured sound power level	²³¹ Guaranteed sound power level
²²¹ Type	kW			²²¹ Type	kW		
G10	8	90,6L _{WA}	91L _{WA}	G100	80	94,3L _{WA}	95L _{WA}
G20	16	93,6L _{WA}	94L _{WA}	G150	120	95,6L _{WA}	96L _{WA}
G30	25	93,5L _{WA}	94L _{WA}	G200	160	95,8L _{WA}	96L _{WA}
G40	32	95,1L _{WA}	96L _{WA}	G250	205	96,5L _{WA}	97L _{WA}
G60	48	91,7L _{WA}	92L _{WA}	G400	328	97,7L _{WA}	98L _{WA}
G80	64	93,3L _{WA}	94L _{WA}	G500	400	98,2L _{WA}	99L _{WA}

Jan Moravec
²⁷¹ Engineering Manager

²⁸¹ Issued at Dobruška, Czech Republic











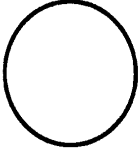
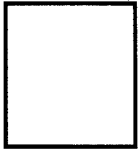

²⁹¹ Date

³⁰¹ The technical documentation for the machinery is available from:
Doosan Infracore Portable Power EMEA, Dreve Richelle 167, B-1410 Waterloo, Belgium



Safety Symbols

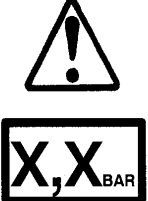

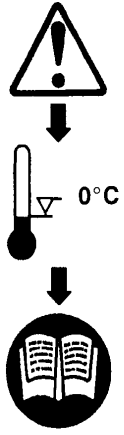









GRAPHIC FORM AND MEANING OF ISO SYMBOLS

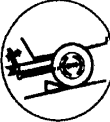

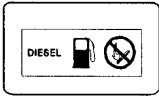

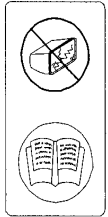
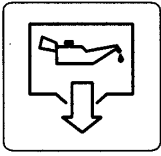
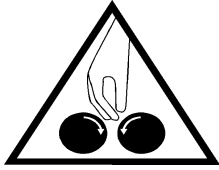
 Prohibition / Mandatory	 Information / Instructions	 Warning
 WARNING: Electrical shock risk.	 WARNING - Pressurised component or system.	 WARNING - Hot surface.
 WARNING - Pressure control.	 WARNING - Corrosion risk.	 WARNING - Air/gas flow or Air discharge.
 WARNING - Pressurised vessel.	 WARNING - Hot and harmful exhaust gas.	 WARNING - Maintain correct tyre pressure. (Refer to the GENERAL INFORMATION section of this manual).
 WARNING - Flammable liquid.	 WARNING - Before connecting the tow bar or commencing to tow consult the operation and maintenance manual.	 WARNING - For operating temperature below 0°C, consult the operation and maintenance manual.

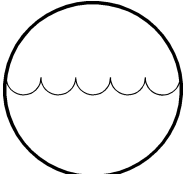
7/26E, 7/31E, 7/41, 7/51

 <p>WARNING - Do not undertake any maintenance on this machine until the electrical supply is disconnected and the air pressure is totally relieved.</p>	 <p>WARNING - Consult the operation and maintenance manual before commencing any maintenance.</p>	 <p>Do not breathe the compressed air from this machine.</p>
 <p>Do not remove the Operating and Maintenance manual and manual holder from this machine.</p>	 <p>Do not stack.</p>	 <p>Do not operate the machine without the guard being fitted.</p>
 <p>Do not stand on any service valve or other parts of the pressure system.</p>	 <p>Do not operate with the doors or enclosure open.</p>	 <p>Do not use fork lift truck from this side.</p>
 <p>Do not exceed the trailer speed limit.</p>	 <p>No naked lights.</p>	 <p>Do not open the service valve before the airhose is attached.</p>
 <p>Use fork lift truck from this side only.</p>	 <p>Emergency stop.</p>	 <p>Tie down point</p>

7/26E, 7/31E, 7/41, 7/51

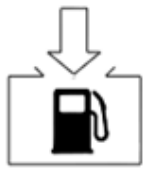
 <p>Lifting point.</p>	 <p>On (power).</p>	 <p>Off (power).</p>
 <p>Read the Operation and Maintenance manual before operation or maintenance of this machine is undertaken.</p>	 <p>When parking use prop stand, handbrake and wheel chocks.</p>	 <p>Compressor oil filling</p>
 <p>Diesel fuel No open flame.</p>	 <p>Parking brake.</p>	 <p>Rough Service Designation. Wet Location Operation.</p>
 <p>Replace any cracked protective shield.</p>	 <p>Oil drain.</p>	 <p>Crush Warning</p>
 <p>No Water</p>	 <p>Coolant Fill</p>	 <p>No Flame</p>

				
	1.	2.	3.	

Fill with fuel before start-up



Safety

Safety

DANGER

This machine is not designed for operating life-sustaining equipment. It is equipped with a safety shutdown system that will cause the machine to stop operating whenever a shutdown condition is present.

DANGER

Never operate the engine of this machine inside a building without adequate ventilation. Avoid breathing exhaust fumes when working on or near the machine.

WARNING

A battery contains sulfuric acid and can give off gases which are corrosive and potentially explosive. Avoid contact with skin, eyes, and clothing. In case of contact, flush area immediately with water.

WARNING

Improper operation of this equipment can cause severe injury or death. Read Operator's Manual supplied with this machine before operation or service.

Modification or alteration of this machine CAN result in severe injury or death. Do not alter or modify this machine without the express written consent of the manufacturer.

WARNING

This machine is equipped with an Auto Start System, which can cause the machine to start at any time. Follow all safety recommendations outlined in this manual to avoid injury to personnel. **DISCONNECT BATTERY BEFORE SERVICING.**

 **CAUTION**

Exercise extreme caution when using booster battery. To jump battery, connect ends of one booster cable to the positive (+) terminal of each battery. Connect one end of other cable to the negative (-) terminal of the booster battery and other end to a ground connection away from dead battery (to avoid a spark occurring near any explosive gases that may be present). After starting unit, always disconnect cables in reverse order.

 **WARNING**

Never inspect or service unit without first disconnecting battery cable(s) to prevent accidental starting.

Wear eye protection while cleaning unit with compressed air, to prevent debris from injuring eyes.

 **WARNING**

HOT PRESSURIZED FLUID - Remove cap slowly to relieve **PRESSURE** from **HOT** radiator. Protect skin and eyes. **HOT** water or steam and chemical additives can cause serious personal injury.

 **WARNING**

Flammable Fuels - Do not fill tank when engine is running.

Do not smoke or use an open flame in the vicinity of the generator set or fuel tank. Do not permit smoking, open flame, or sparks to occur near the battery, fuel, cleaning solvents or other flammable substances and explosive gases.

Do not operate Genset if fuel has been spilled inside or near the unit.

 **WARNING****Electrical Shock -**

Do not operate electrical equipment while standing in water, on wet ground or with wet hands or shoes.

Use extreme caution when working on electrical components. Battery voltage (12V/24V DC) is present unless the battery cables have been disconnected. Higher voltage (potentially 480V) is possibly present at all times.

 **WARNING**

Always treat electrical circuits as if they were energized.

Disable Start Control before attempting any repair service, disconnect all leads to electrical power requirements and disconnect battery to prevent start up.

GROUNDING

Comply with applicable electrical codes.

 **WARNING**

The Generator Set can produce high voltages, which can cause severe injury or death to personnel and damage to equipment. The Generator Set should have proper internal and external ground when required by IEC 364-4-41.

The Generator Set is internally grounded neutral to the frame of the Generator Set. This internal ground connection is essential for proper Generator Set performance and personal protection.

External grounding consists of connecting the generator neutral to a solid earth ground, and is the responsibility of the operator, when grounding is required by IEC 364-4-41 Protection Against Electric Shock, and other local codes as applicable.

Several methods are employed to externally ground portable generator sets, depending on the intended use and code requirements. In all cases, a continuous length of splice-free copper cable, no smaller than 10 mm², shall be used for the external ground conductor, when grounding is required.

A qualified, licensed electrical contractor, knowledgeable in local codes, should be consulted.

 **WARNING**

Failure to properly ground the Generator Set can result in severe injury or death.

IF USED AS ALTERNATE POWER SUPPLY

Connect only after the main service entrance switch has been DISCONNECTED and LOCKED OPEN. In addition, circuit overload protection must be provided in accordance with National Electrical Codes and local regulations.

 **CAUTION****Welding -**

Prior to any welding, disconnect alternator relays, diagnostic circuit board, voltage regulator circuit board, meters, circuit breakers and battery cables. Open all circuit breakers, and remove any external connections (except grounding rod). Connect the welding ground as close as possible to the area being welded.

 **WARNING****Electrical Loading -**

Never make electrical connections with the unit running.

Before placing the unit in operation, verify the electrical rating of the Generator Set and do not exceed generator set ratings.



Use extreme care to avoid contacting hot surfaces (engine exhaust manifold and piping).

HAZARDOUS SUBSTANCE PRECAUTION

Ensure that adequate ventilation of the cooling system and exhaust gases is maintained at all times.

The following substances are used in the manufacture of this machine and may be hazardous to health if used incorrectly.

Avoid ingestion, skin contact and breathing fumes for the following substances: Antifreeze, Engine Lubricating Oil, Preservative Grease, Rust Preventative, Diesel Fuel and Battery Electrolyte.

The following substances may be produced during the operation of this machine and may be hazardous to health:

- Avoid build-up of engine exhaust fumes in confined spaces.
- Avoid breathing exhaust fumes.
- Avoid breathing brake lining dust during maintenance.
- Always operate in a well ventilated area.



General Data

General Data

UNIT MODEL	G10 (1PH)	G10 (3PH)	G20	G30	G40	G60	G80
Engine Speed - RPM	1500	1500	1500	1500	1500	1500	1500
Engine Fuel	Diesel	Diesel	Diesel	Diesel	Diesel	Diesel	Diesel
Manufacturer	Mitsubishi	Mitsubishi	Mitsubishi	Mitsubishi	Mitsubishi	John Deere	John Deere
Model	S3L2-611R	S3L2-611R	S4Q2-Z361SD	S4S-Z361SD	S4S-Z3DT61SD	4045TF270	4045HF275
FLUID CAPACITIES							
Engine Crankcase Lubricant (Liters)	4.2	4.2	6.5	10	10	14.8	14.8
Fuel Tank (Liters)	101	101	150	199	413	413	716
Radiator & Engine Coolant (Liters)	4.2	4.2	9.1	11.4	11.4	22.7	26.5
Electrical System	12VDC	12VDC	12VDC	12VDC	12VDC	12VDC	12VDC
UNIT MEASUREMENTS/ WEIGHTS							
Overall length (mm)	1567	1567	1862	2165	2471	2471	2720
Overall width (mm)	851	851	889	1003	1003	1003	1214
Overall height (mm)	1118	1118	1382	1448	1750	1750	1763
Weight (with fuel) (kg)	694	694	999	1329	1649	1949	2377
Weight (less fuel) (kg)	608	608	846	1134	1260	1560	1714

UNIT MODEL	G100	G160	G200	G250	G400	G500
Engine Speed - RPM	1500	1500	1500	1500	1500	1500
Engine Fuel	Diesel	Diesel	Diesel	Diesel	Diesel	Diesel
Manufacturer	John Deere	John Deere	John Deere	Cummins	Cummins	Cummins
Model	4045HF279	6068HF279	6068HF475	QSL9-G3	QSX15-G6	QSX15-G8
FLUID CAPACITIES						
Engine Crankcase Lubricant (Liters)	14.8	32.5	32.5	26.5	91	91
Fuel Tank (Liters)	716	961	961	1461	2173	2173
Radiator & Engine Coolant (Liters)	26.5	31.2	31.2	32	57	57
Electrical System	12VDC	12VDC	12VDC	24VDC	24VDC	24VDC
UNIT MEASUREMENTS/ WEIGHTS						
Overall length (mm)	2720	3566	3566	4049	5037	5037
Overall width (mm)	1214	1265	1265	1425	1623	1623
Overall height (mm)	1763	2017	2017	2385	2385	2548
Weight (with fuel) (kg)	2614	3567	3674	4783	7619	7746
Weight (less fuel) (kg)	1951	2678	2785	3441	5622	5749

General Info

G10 INFORMATION ON AIRBORNE NOISE

- The A-weighted emission sound pressure level
77 dB(A), uncertainty 1 dB(A)
- The A-weighted emission sound power level
92 dB(A), uncertainty 1 dB(A)

The operating conditions of the machinery are in compliance with ISO 3744:1995 and EN ISO 8528-10:1998

G20 INFORMATION ON AIRBORNE NOISE

- The A-weighted emission sound pressure level
80 dB(A), uncertainty 1 dB(A)
- The A-weighted emission sound power level
94 dB(A), uncertainty 1 dB(A)

The operating conditions of the machinery are in compliance with ISO 3744:1995 and EN ISO 8528-10:1998

G30 INFORMATION ON AIRBORNE NOISE

- The A-weighted emission sound pressure level
80 dB(A), uncertainty 1 dB(A)
- The A-weighted emission sound power level
94 dB(A), uncertainty 1 dB(A)

The operating conditions of the machinery are in compliance with ISO 3744:1995 and EN ISO 8528-10:1998

G40 INFORMATION ON AIRBORNE NOISE

- The A-weighted emission sound pressure level
81 dB(A), uncertainty 1 dB(A)
- The A-weighted emission sound power level
96 dB(A), uncertainty 1 dB(A)

The operating conditions of the machinery are in compliance with ISO 3744:1995 and EN ISO 8528-10:1998

G60 INFORMATION ON AIRBORNE NOISE

- The A-weighted emission sound pressure level
78 dB(A), uncertainty 1 dB(A)
- The A-weighted emission sound power level
92 dB(A), uncertainty 1 dB(A)

The operating conditions of the machinery are in compliance with ISO 3744:1995 and EN ISO 8528-10:1998

G80 INFORMATION ON AIRBORNE NOISE

- The A-weighted emission sound pressure level
81 dB(A), uncertainty 1 dB(A)
- The A-weighted emission sound power level
94 dB(A), uncertainty 1 dB(A)

The operating conditions of the machinery are in compliance with ISO 3744:1995 and EN ISO 8528-10:1998

G100 INFORMATION ON AIRBORNE NOISE

- The A-weighted emission sound pressure level
82 dB(A), uncertainty 1 dB(A)
- The A-weighted emission sound power level
96 dB(A), uncertainty 1 dB(A)

The operating conditions of the machinery are in compliance with ISO 3744:1995 and EN ISO 8528-10:1998

G160 INFORMATION ON AIRBORNE NOISE

- The A-weighted emission sound pressure level
80 dB(A), uncertainty 1 dB(A)
- The A-weighted emission sound power level
95 dB(A), uncertainty 1 dB(A)

The operating conditions of the machinery are in compliance with ISO 3744:1995 and EN ISO 8528-10:1998

G200 INFORMATION ON AIRBORNE NOISE

- The A-weighted emission sound pressure level
80 dB(A), uncertainty 1 dB(A)
- The A-weighted emission sound power level
97 dB(A), uncertainty 1 dB(A)

The operating conditions of the machinery are in compliance with ISO 3744:1995 and EN ISO 8528-10:1998

G250 INFORMATION ON AIRBORNE NOISE

- The A-weighted emission sound pressure level
84 dB(A), uncertainty 1 dB(A)
- The A-weighted emission sound power level
97 dB(A), uncertainty 1 dB(A)

The operating conditions of the machinery are in compliance with ISO 3744:1995 and EN ISO 8528-10:1998

G400 INFORMATION ON AIRBORNE NOISE

- The A-weighted emission sound pressure level
84 dB(A), uncertainty 1 dB(A)
- The A-weighted emission sound power level
98 dB(A), uncertainty 1 dB(A)

The operating conditions of the machinery are in compliance with ISO 3744:1995 and EN ISO 8528-10:1998

G500 INFORMATION ON AIRBORNE NOISE

- The A-weighted emission sound pressure level
85 dB(A), uncertainty 1 dB(A)
- The A-weighted emission sound power level
99 dB(A), uncertainty 1 dB(A)

The operating conditions of the machinery are in compliance with ISO 3744:1995 and EN ISO 8528-10:1998.



Operating Instructions

Operating Instructions

Never operate unit without first observing all safety warnings and carefully reading the operation and maintenance manual shipped from the factory with this machine.

BEFORE STARTING

1. Fill with CLEAN diesel fuel. Units are shipped without fuel.
2. Ensure load wiring connections are tight.
3. Check for fluid leaks.
4. Check for fluid level in container base.
5. Check engine oil and coolant level.
6. Check proper grounding circuit. Refer to Safety-Grounding.
7. Check for frayed or loose fan belts, hoses or wiring insulation.
8. Check for leaves, paper, debris in air vents.

WARNING

Do not remove the cap from a HOT engine radiator. The sudden release of pressure from a heated cooling system can cause severe injury or death.

STARTING**CAUTION**

Use the **EMERGENCY STOP** button **ONLY** in the event of an emergency. **NEVER** use it for normal shut-down.

Verify the following:

1. All external electrical power loads are turned "OFF".
2. Main Breaker is "OFF".
3. Battery Disconnected Switch is "ON".
4. Reset (pull to unlatch) Emergency Stop Button.
5. Push the Engine "START" Button.
6. Wait for preheating if enabled.

**CAUTION**

Do **NOT** use engine starting fluids.

**DANGER**

POWER is present upon cranking the engine.

**CAUTION**

Allow starter to cool for one minute between start attempts. If engine does not start after a few attempts, refer to Engine O&M Book.

If engine shuts down, diagnostic lamps will indicate the problem. Correct the problem before continuing.

7. Allow the engine to warm-up for 3 to 5 minutes. If the engine stops unexpectedly, refer to Trouble Shooting Section.
8. Check the CONTROL Panel for proper voltages. No RED diagnostic lamps should be glowing. Otherwise, shut down the unit and refer to Trouble Shooting.
9. With main breaker "ON" power is present and available for use.
10. Close side doors for optimum cooling of the unit while running.

STOPPING

1. Turn off all external electrical power loads.
2. Turn Main Breaker "OFF".
3. Allow 5 minute cool down.
4. Push Engine "STOP" Button.
5. Wait at least 15 seconds before restarting.
6. Fill fuel tank at end of working day to prevent condensate.

REMOTE STARTING AND STOPPING

1. Connect the Remote Start contacts (located in the Generator System direct hook-up compartment) to a customer-supplied contact that closes to initiate a genset start.
2. Push the Autostart Mode Switch to illuminate the Autostart Mode LED on control panel.
3. When the customer contact closes, a 10-second alarm will sound prior to each crank cycle until the engine starts. Preheating will also occur if enabled.
4. The engine will stop when the customer-supplied contact opens, and the controller will return to Auto Start Mode.

DIAGNOSTICS/AUTO SHUTDOWN

The operating controls and instruments are arranged on the control panel as shown. A description of each panel device is as follows:

1. **High Engine Temperature** - Indicates engine shutdown due to high coolant temperature or low coolant level.
2. **Low Engine Oil Pressure** - Indicates engine shutdown due to low engine oil pressure.
3. **Low Fuel Level** - Indicates engine shutdown due to low fuel level.

4. **High Containment Level** - Indicates high level of fluids in the containment base.
5. **Over Crank** - Indicates engine did not start after 3 cranks.
6. **Battery Not Charging** - Indicates battery voltage is low or not being charged.
7. **Engine Speed** - Indicates engine overspeed.
8. **Engine Operating** - Indicates engine is cranking or operating.
9. **Preheat** - Indicates preheating is on.
10. **Engine Communication** - Indicates the controller has communication with the engine ECU.
11. **Engine Fault** - Indicates that engine service may be required.

ENGINE CONTROLS and INSTRUMENTS

12. **Engine Start Switch**
13. **Engine Stop/Reset Switch** - Stops engine and resets diagnostics. Also, awakens controller from sleep mode. Wait 15 seconds for reset to complete before attempting start.
14. **Autostart Mode Switch** - Puts engine in Autostart Mode.
15. **Autostart Mode** - Indicates genset is in Autostart Mode. Note: the controller will enter low power sleep mode after a short time and all other LED's will go off.
16. **Emergency Stop Switch** - Disables running, cranking, and trips main breaker.

17. **Alarm Horn** - Sounds prior to a start when in Auto Start Mode.

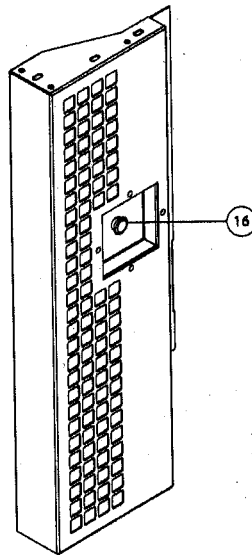
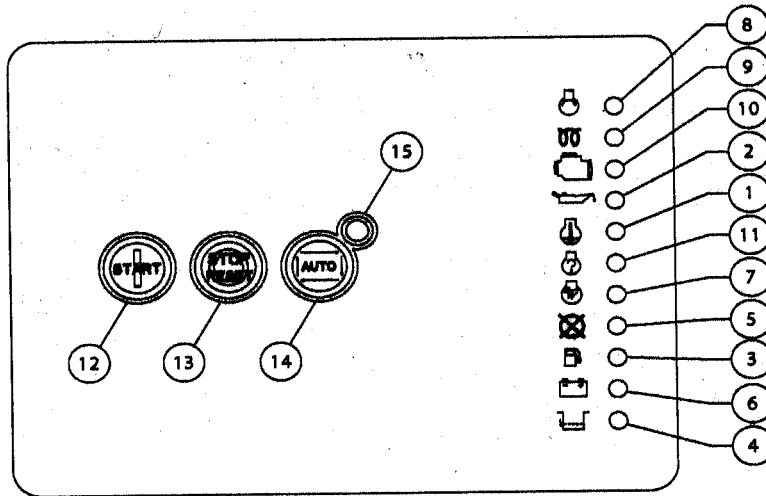

GENERATOR SYSTEM

METERS

1. **AC VOLTS** - Indicates the generator output voltage.
2. **AC AMPERES** - Indicates the generator load in amperes corresponding to AMPERAGE OUTPUT MONITOR switch position.
3. **Hertz** - Indicates frequency of generator output.
4. **Panel Lamp** - Illumination Only.
5. **Battery Voltage** - Indicates battery charging voltage.
6. **Fuel** - Indicates fuel level in tank.

MONITOR SWITCHES

7. **Amperage Output** - Selects the line (phase) amperage to be displayed on the AC Ammeter.
8. **Voltage Adjust Rheostat (VAR)** - Turn to adjust generator output voltage.
9. **Hourmeter**- Records running time for maintenance.

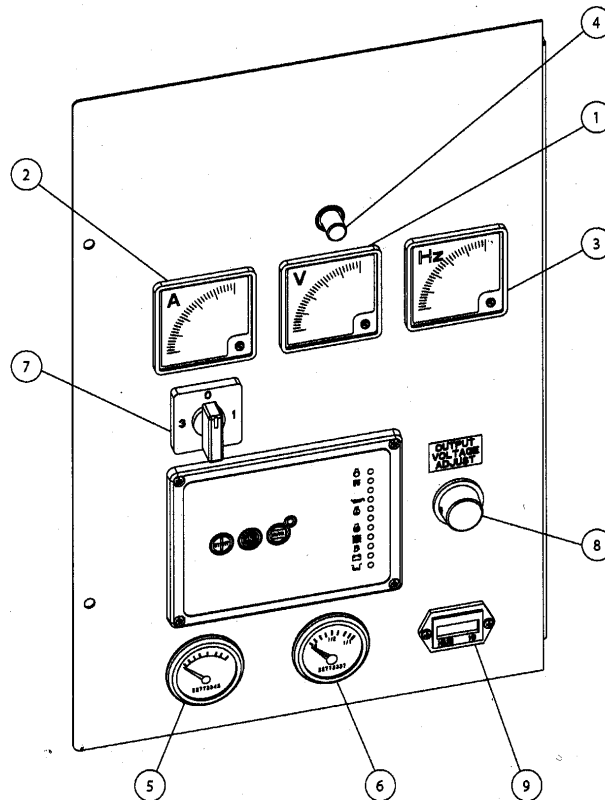

PROTECTION/REGULATION

10. **3 Phase Direct Hookup Connections** - L₁, L₂, L₃, N (neut), PE (Protective Earth Ground). (not shown).
11. **Fuse Holders**- Fuses for voltage output meter. (not shown)
12. **Residual Current Release Device (RCD)**- Provides earth leakage protection. (not shown).
13. **Main Circuit Breaker** - (not shown)
14. **Alarm Horn** - (not shown) but is located on back of control box.

Voltage Adjustment Range	
Line - Neutral	Line - Line
L ₁ -N, L ₂ -N, L ₃ -N	L ₁ -L ₂ , L ₁ - L ₃ , L ₂ - L ₃
207V - 253V	360V - 440V

STARTING (KEY START MODELS) **CAUTION**

Use the **EMERGENCY STOP** button **ONLY** in the event of an emergency. **NEVER** use it for normal shut-down.

Verify the following:

1. All external electrical power loads are turned “OFF”.
2. Main Breaker is “OFF”.
3. Battery Disconnected Switch is “ON”.
4. Reset (pull to unlatch) Emergency Stop Button.
5. Turn the ENGINE START SWITCH to “PREHEAT” for maximum of 10 seconds for cold weather starts.
6. Turn ENGINE START switch to “START”. Release after engine starts.

 **CAUTION**

Do **NOT** use engine starting fluids.

 **DANGER**

POWER is present upon cranking the engine.

 **CAUTION**

Allow starter to cool for one minute between start attempts. If engine does not start after a few attempts, refer to Trouble Shooting.

If engine shuts down when ENGINE START switch is in the “ON” position, diagnostic lamps will indicate the problem. Correct the problem before continuing.

7. Allow the engine to warm-up for 3 to 5 minutes. If the engine stops unexpectedly, refer to Trouble Shooting Section.
8. Check the CONTROL Panel for proper voltages. No RED diagnostic lamps should be glowing. Otherwise, shut down the unit and refer to Trouble Shooting.
9. With main breaker "ON" power is present and available for use.
10. Close side doors for optimum cooling of the unit while running.

STOPPING (KEYSTART MODELS)

1. Turn off all external electrical power loads.
2. Turn Main Breaker "OFF".
3. Allow 5 minute cool down.
4. Push Engine "STOP" Button.
5. Wait at least 15 seconds before restarting.
6. Fill fuel tank at end of working day to prevent condensate.

DIAGNOSTICS/AUTO SHUTDOWN (KEYSTART MODELS)

The operating controls and instruments are arranged on the control panel as shown. A description of each panel device is as follows:

1. **High Engine Temperature** - Indicates engine shutdown due to high coolant temperature or low coolant level.
2. **Low Engine Oil Pressure** - Indicates engine shutdown due to low engine oil pressure.
3. **Engine Start Switch Positions** - OFF, RUN, PREHEAT, START.
4. **Emergency Stop** - Disables running, cranking, and trips main breaker.
5. **Hourmeter** - Records operating time.
6. **Controller** - (Not shown)

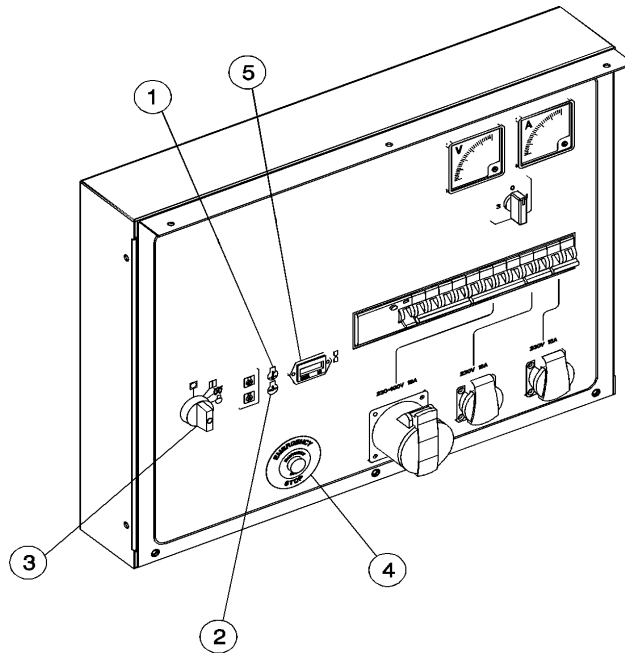

GENERATOR SYSTEM (KEYSTART MODELS)

METERS

1. **AC VOLTS** - Indicates the generator output voltage.
2. **AC AMPERES** - Indicates the generator load in amperes corresponding to AMPERAGE OUTPUT MONITOR switch position.

MONITOR SWITCHES

3. **Amperage Output** - Selects the line (phase) amperage to be displayed on the AC Ammeter.

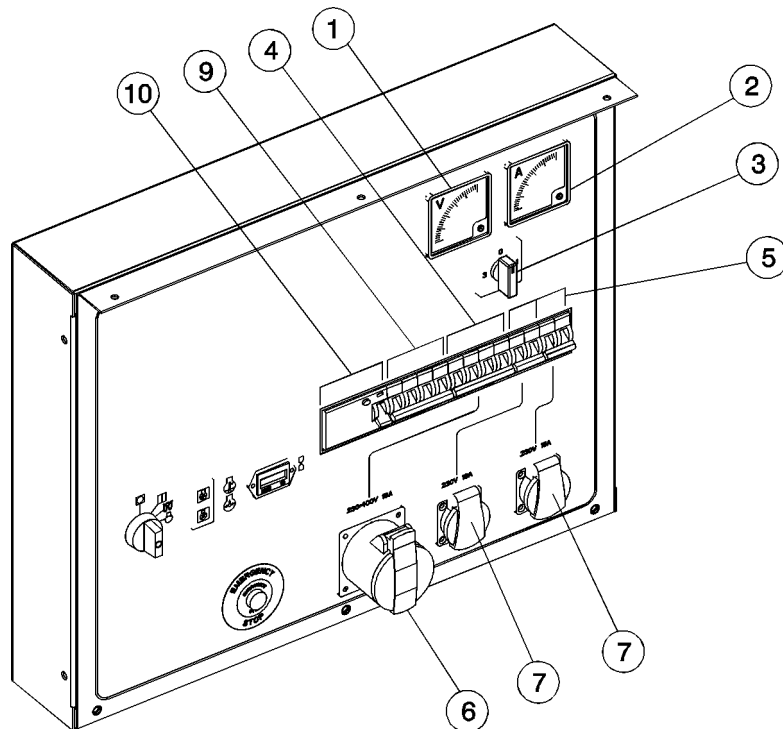

CIRCUIT BREAKERS - Flip to Reset (if equipped)

4. **16 Amp/400V Socket**
5. **16 Amp/230V Socket**

SOCKETS (if equipped)

6. **400V - 3 Phase**
7. **230V - 1 Phase**

PROTECTION/REGULATION

- 8. **Fuse Holders** - Fuses for voltage output selector switch and meter. (not shown).
- 9. **Main Circuit Breaker** -
- 10. **RCD Breaker** - (Earth Leakage)

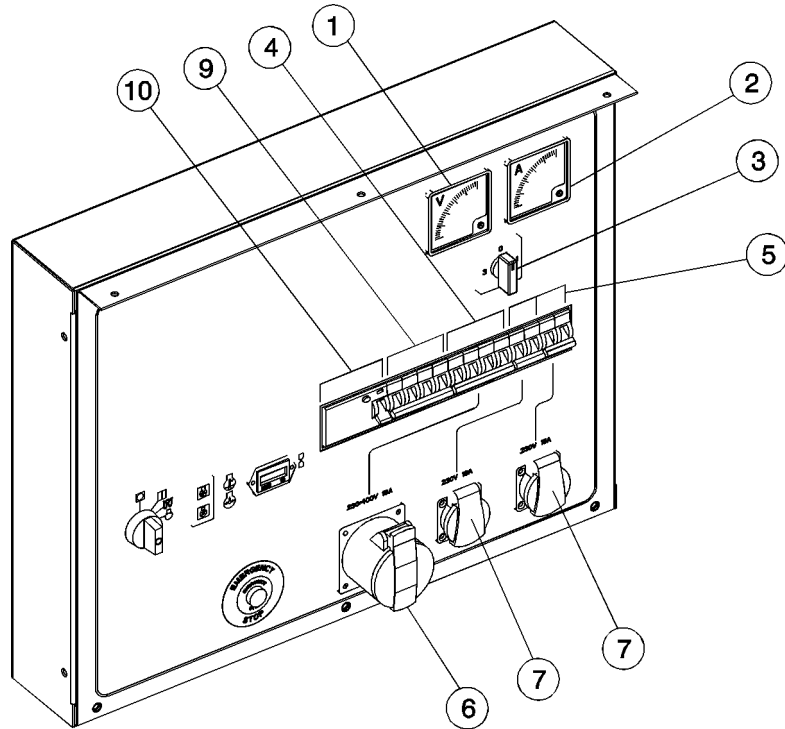

Voltage Adjustment Range	
Line - Neutral	Line - Line
L ₁ -N, L ₂ -N, L ₃ -N	L ₁ -L ₂ , L ₁ - L ₃ , L ₂ - L ₃
207V - 253V	360V - 440V

BASIC DIGITAL CONTROLS OPERATION

Overview

Doosan's Digital Controller is a comprehensive generator set controller that is used as the primary interface between the operator and the generator set. It provides a high degree of engine and generator protection. Multiple real-time parameters can also be viewed. The parameters include, but are not limited to kW, KVA, kVAr, power factor, oil pressure, coolant temperature, engine speed, and diagnostic history.

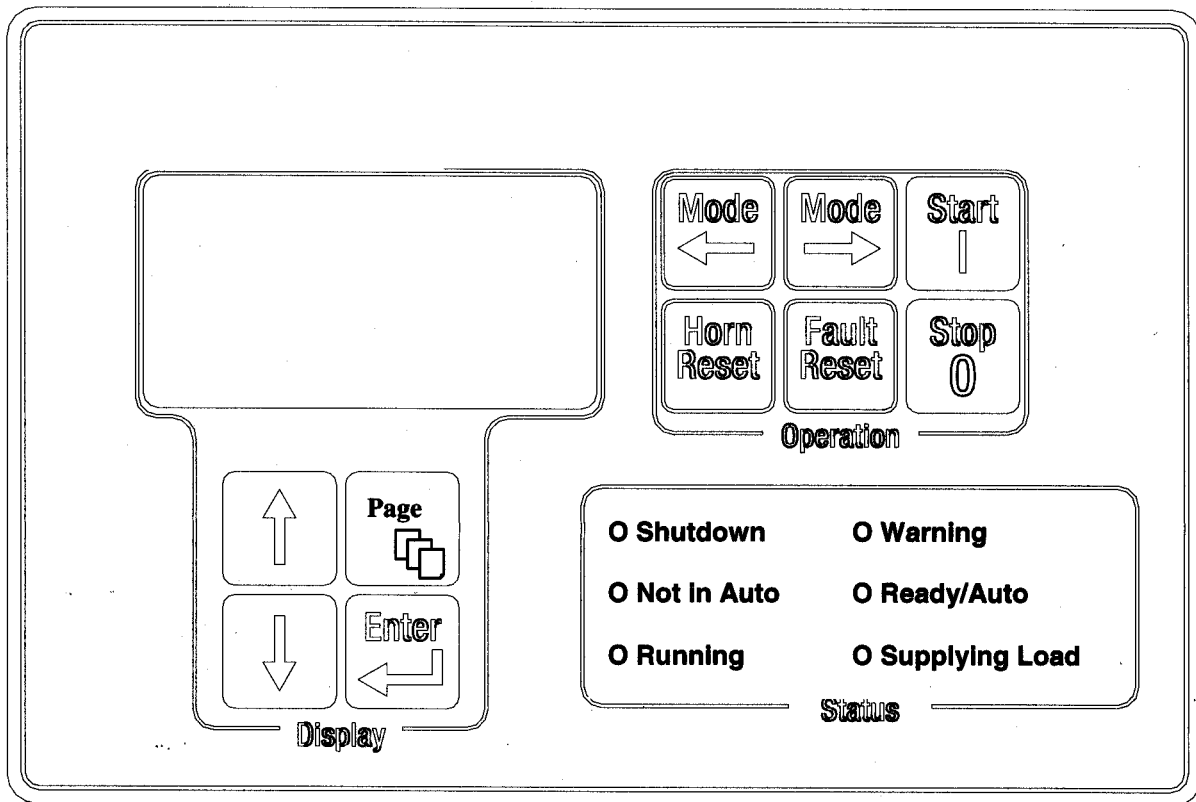

Front View of the Digital Controller

IDENTIFYING KEYPAD BUTTONS AND INDICATORS

OPERATION BUTTONS



Press this button to **START** the generator set.

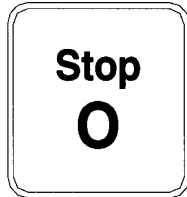

Press this button to **STOP** the generator set.



Press this button to deactivate the horn.



Press this button to clear inactive faults.

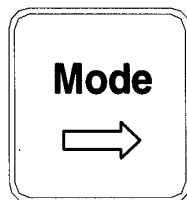

Use this button to scroll the generator operation mode from **OFF-MAN-AUT**.

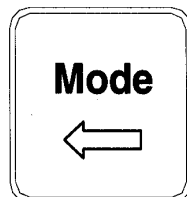

Use this button to scroll the generator operation mode from **AUT-MAN-OFF**.

DISPLAY BUTTONS

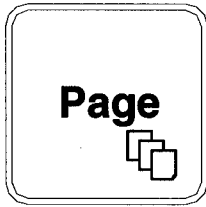

Use this button to scroll the display between the measurement screen, adjustment screen, and the fault screen. Use it also to back out of screens.

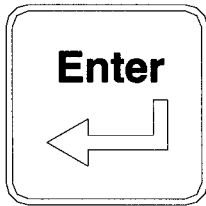

Use this button to select an adjustment parameter and to confirm proper adjustment.

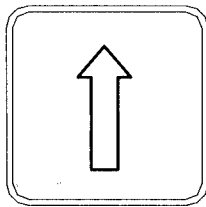

Use this button to INCREASE setpoint values and to scroll up the adjustment menu.

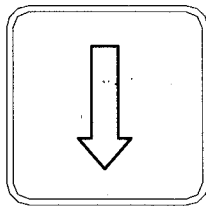

Use this button to DECREASE setpoint values and to scroll down the adjustment menu.

Status LED's

Shutdown - Indicates the generator set has shutdown due to a fault.

Not in Auto - Indicates that the generator set operation mode is not in the automatic position.

Running - Indicates that the generator set is running.

Warning - Indicates that the generator set is operating in a condition outside its normal operational parameters.

Ready/Auto - Indicates the generator set is ready and is in automatic mode.

Supplying Load - Indicates that the generator set is under load.

VIEWING REAL-TIME DATA - ACCESSING THE SCREENS

Press the  button until you reach the primary operational screen.

Use the   to scroll between screens.

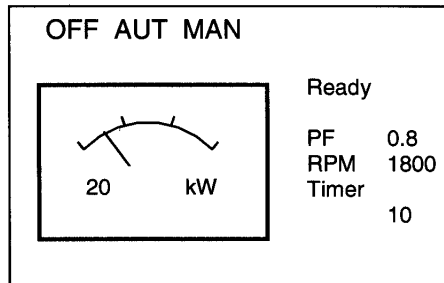

This is the primary optional screen which identifies the status of the generator set along with the generator kW, power factor, and engine RPM.

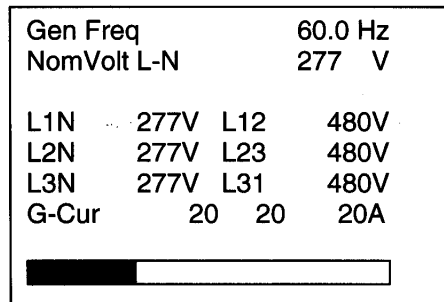

This screen displays electrical values of the generator set. These values include frequency, line voltages, phase voltages, and current per phase.

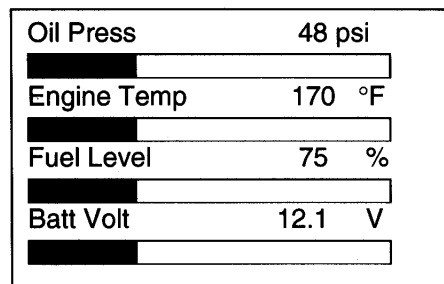

This screen displays the engine operational data of the generator set.

BIN	I000000
Rem Start/Stop	I
Low Coolant	0
Emergency Stop	0
Low Fuel	0
Full Basin	0
Voltage Select	0
VSS Door	0

This screen displays the status of the binary inputs of the controller. "I" indicates that an input has changed state and "0" indicates no change of state.

BOUT	0000I00
Starter	0
Fuel Solenoid	0
Fuel Pull Coil	0
Glow Plugs	0
IL Power	I
Horn	0
GCB Trip	0

This screen displays the status of the outputs of the controller. "I" indicates that an output has changed state and "0" indicates no change of state.

ECU State	000
ECU Yellow Lamp	0
ECU Red Lamp	0
Wait to Start	0

This screen is ONLY shown on Engines utilizing J1939 engine communications. Indication of faults/shutdowns from the engine control unit is shown here. The ECU Yellow Lamp indicates an engine warning and the ECU Red Lamp indicates an engine shutdown.

ECU Values	
Oil Pressure	xxxxx
Water Temp	xxxxx
Perc Load ATCS	xxx
Boost Pressure	xxx
Manifold Temp	xxxxx
Fuel Rate	xxxxx

This screen is ONLY shown on engines utilizing J1939 engine communications. The data is sent from the engine ECU.

Act Power			0kW
0	0		0
Pwr factor		0.00	
0.00	0.00		0.00
React pwr			0kVAr
0	0		0
Appar Pwr			0kVA
0	0		0

This screen displays the load parameters of the generator set in terms of active power, power factor, reactive power, and apparent power. These values are indicated in total and per phase.

Run Hours	0	h
NumStarts	0	
E-Stop	0	
Shutdown	0	
KW hours	0	
KVAr hours	0	
Next Srv Time	250	h

This screen displays operational information of the generator set in terms of run hours, number of starts, number of e-stops, and shutdowns, kW hours, kVAr hours. Also shown is a definable parameter for service intervals.

ECU Alarm List					
>					
...					
FC	0	OC	0	FMI	0

This screen is ONLY shown on engines utilizing J1939 Communications. The SPN and FMI diagnostic codes are shown here as sent from the engine ECU. These Faults are non latching and are not present when the Fault is not present. A full listing of Fault Codes is shown at the end of this manual.

Alarm List	2
Not in Auto	
Wrn Coolant Level	

This screen displays the alarm/shutdown list of the generator set. Inactive faults can be cleared by pressing the "Fault Reset" button. Up to eight faults can be displayed on this screen and are "first-in-first out".

CHECKING SOFTWARE VERSION/LAMP TEST

To check the software version and to test the operation of the LED's on the control panel, simultaneously press

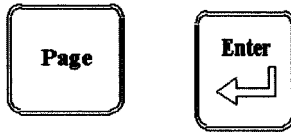

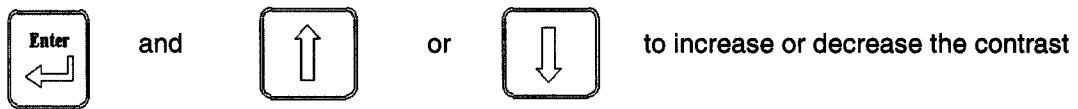

ADJUSTING THE CONTRAST ON THE LCD

To adjust the contrast on the LCD display, simultaneously press





PARAMETER ADJUSTMENTS VIA KEYPAD

Press the  button until you reach the parameter adjustment menu.

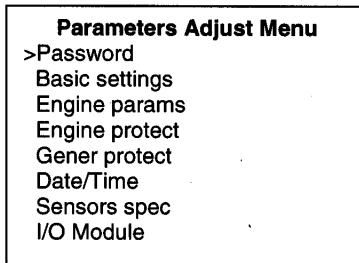

Use the   to scroll through the parameter menus.





Press  to select the desired parameter menu.

Use the   to scroll to the parameter to be adjusted.

Press  to select parameter to be adjusted. Note: Parameters preceded by an asterisk * require password access.

Use the   to increase or decrease the setpoint value.

When the desired setpoint is reached, press 

Press the  button once to get back to the parameter menu and twice more to go back to the measurement screen.

SETPOINTS DESCRIPTIONS**BASIC SETTINGS****Gen-Set Name**

User defined name, used for the CONTROLLER identification at remote phone or mobile connection. The Gen-set name is max 14 characters long and has to be entered using Lite Edit software.

Nomin Power (3ph)

Nominal power of the generator in three phase HI-WYE series connection.

Nomin Current

Nominal current of the generator in three phase LOW-WYE parallel connection.

CT Ratio

The generator set current transformer ratio.

PT Ratio

The generator set potential transformers ratio. PT's are not needed on 480 Volt systems and below.

Nominal Voltage 1

Line to neutral voltage in LOW-WYE, Parallel connection.

Nominal Voltage 2

Line to neutral voltage in HI-WYE, series connection.

Gear Teeth

Number of teeth on the engine gear for the pick-up. Set to zero, if no pick-up is used. Engine speed is counted from the generator frequency. Electronic engines get the speed signal from the engine controller.

Alternator Frequency

Frequency of the battery alternator when the controller stops cranking.

Nominal RPM

The nominal engine speed of the generator set.

Mode [OFF, MAN, AUT]

This is the equivalent of controller "Mode" buttons.

Fault Reset Go to Manual

Enables or Disables return to MAN mode when reset is pushed.

Display Backlight Timeout

The time limit in minutes for the backlight to go off.

IL Power OFF

The time limit in minutes for the controller to go to Sleep Mode. The control power is restored by pushing the Control Power Button for 5 seconds.

Controller ADDR

The setting of the controller address.

RS232 Mode

The communication protocol selection.

- Standard = Lite Edit
- Modbus = Modbus Protocol
- Cummins MB = Cummins Modbus Protocol

ENGINE PARAMETERS

Start RPM

"Firing" speed when controller stops cranking (starter goes OFF).

Starting POil

When reached, controller stops cranking (starter goes OFF). There are three conditions for stop cranking: Starting RPM, Starting POil and D+ (when enabled). The starter goes off when any of these conditions are valid.

PreHeat Time

The time delay for preheating after the unit gets the start command. The unit begins to start after preheating. Select No Preheat with a setting = 0. Factory default setting = 10 seconds.

MaxCrank time

Maximum time limit of cranking.

Crank Fail Pause

Pause time between crank attempts.

Crank Attempts

Maximum number of crank attempts.

Idle Time

Idle time delay starts when RPM exceeds Start RPM. Start fail is detected when during idle state RPM decrease below 2.

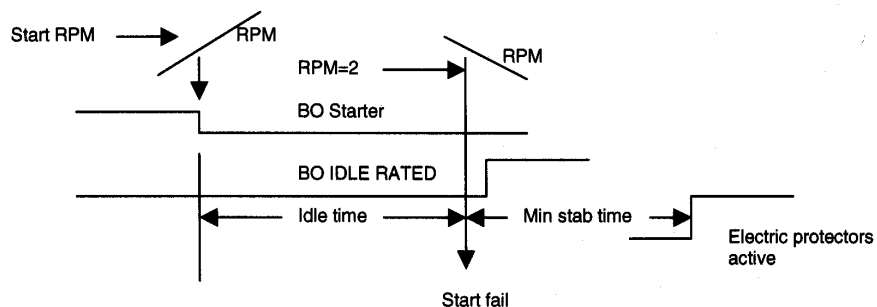

Min Stability Time

Generator nominal voltage starts being detected after starter is switched off, idle time elapses, and this time has elapsed.

Max Stability Time

If generator nominal voltage is not stable within the time after starter is OFF and idle time elapses, then the genset will shutdown. Stability means that voltage and frequency are within warning setting limits.

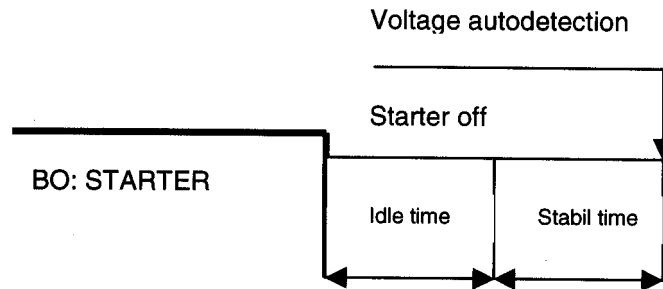

Cooling Speed

This function is not used. Reserved for future applications. Factory default setting = NOMINAL.

Cooling Time

Runtime of the unloaded generator set to cool the engine before stop.

After Cool Time

This function is not used. Factory default setting = 0.

Stop Time

When genset stop sequence is initiated, fuel solenoid output cannot activate during this time.

Fuel Solenoid

Determines behavior of the Binary output FUEL SOLENOID.

DIESEL: Output closes together with Binary output STARTER.

The output opens if Emergency stop comes or Cooled generator set is stopped or in pause between repeated starts.

GAS: Output closes together with Binary output IGNITION if RPM is over the 30 RPM (Fix value). Output opens after stop command or in pause between repeated start.

Fuel Pull Coil

Time duration that output Fuel Pull Coil is active. This output is used for momentary activation of a fuel solenoid pull coil.

D+ Function

ENABLED: The D+ terminal is used for both functions - "running engine" detection and charge fail detection.

CHRGFAIL: The D+ terminal is used for charge fail detection only.

DISABLED: The D+ terminal is not used, but still provides flash voltage to battery alternator.

ECU Freq Select

This function is not used. Factory Setting = DEFAULT.

ECU Speed Adjust

This function is not used. Factory Default Setting = 0

ENGINE PROTECTION**Eng prot del [s]**

During the start of the generator set, some engine protections have to be blocked (e.g. Oil Pressure). The protections are unblocked after the protection del time. The time starts after reaching START RPM.

Alarm Horn

Three selections possible:

NONE = Horn only sounds for 10 seconds prior to a start in Auto Mode.

SHUTDOWN = Horn sounds for any shutdown and also for an Autostart.

SD+ WARNING = Horn sounds for any alarm or shutdown and also for an Autostart.

Overspeed

Threshold for overspeed protection.

Wrn Oil Press

Warning threshold for low oil pressure.

Sd Oil Press

Shutdown threshold level low oil pressure.

Oil Press Del

Delay for oil pressure warning/shutdown.

Sd Engine Temp

Shutdown threshold level for high engine coolant temperature.

Wrn Engine Temp

Warning threshold level for high engine coolant temperature.

Wrn Eng Temp Low

Warning threshold level for low engine coolant temperature.

Engine Temp Del

Delay for high/low engine coolant temperatures.

Wrn Fuel Level

Warning threshold level for low fuel level.

Sd Fuel Level

Shutdown threshold level for low fuel level.

Fuel Level Del

Delay for low fuel level.

Batt Overvolt

Warning threshold for high battery voltage.

Batt Undervolt

Warning threshold for low battery voltage.

Battvolt del

Delay for low battery voltage alarm.

NextServTime [h]

Counts down when engine running. If reaches zero, an alarm appears.

ALTERNATOR PROTECTION**Overload**

Threshold for generator overload (in % of nominal power)

Overload Wrn

Threshold for generator overload warning (in % of nominal power)

Overload del

Delay for generator overload alarm.

Ishort

Shutdown occurs when Ishort circuit limit is reached.

Ishort del

Delay for Ishort Alarm.

2Inom del

IDMT is "very inverse" generator over current protection. 2Inom del is Reaction time of IDMT protection for 200% overcurrent $I_{gen} = 2 \cdot \text{Nominal current}$.

Curr unbal del

Delay for generator current asymmetry.

Gen >V Sd

Shutdown level for generator over voltage. All three phases are checked. Maximum out of three is used.

Gen >V Wrn

Warning level for generator over voltage. All three phases are checked. Maximum out of three is used.

Gen <V Sd

Shutdown level for generator under voltage. All three phases are checked. Minimum out of three is used.

Gen <V Wrn

Warning level for generator under voltage. All three phases are checked. Minimum out of three is used.

Gen V del

Delay for generator under voltage and over voltage alarm.

Volt unbal

Threshold for generator voltage unbalance alarm.

Volt unbal del

Delay for generator voltage unbalance alarm.

Gen >f SD

Shutdown level for generator over frequency.

Gen>f Wrn

Warning level for generator over frequency.

Gen <f Wrn

Warning level for generator under frequency.

Gen <f SD

Shutdown level for generator under frequency.

Gen f del

Delay for generator under frequency and over frequency alarm.

DATE/TIME**Time Stamp Per**

Fixed time interval when history of all parameters is recorded. Factory Default Setting = 0.

Summer Time Mod

Automatic time adjustment for daylight savings time.

Time

Time of day setting.

Date

Date setting

Timer 1 Repeat

Selection of day/days when exercise Timer 1 will run.

Timer 1 on Time

Selection of time of day when Timer 1 will start the genset.

Timer 1 Duration

Selection of length of run time.

Timer 2 Repeat

Selection of day/days when exercise Timer 2 will run.

Timer 2 on Time

Selection of time of day when Timer 2 will start the genset.

Timer 2 Duration

Selection of length of run time.



Maintenance

Maintenance Information

CAUTION

Any unauthorized modification or failure to maintain this equipment may make it unsafe and out of factory warranty.

WARNING

Before attempting any repair service, disconnect engine battery cables and all leads to electrical power requirements. Failure to do so can result in severe personal injury, death or damage to the equipment.

General

In addition to periodic inspections, many of the components in this unit requires periodic servicing to provide maximum output and performance. Servicing may consist of pre-operation and post-operation procedures to be performed by the operating or maintenance personnel. The primary function of preventive maintenance is to prevent failure and consequently, the need for repair. Preventive maintenance is the easiest and the least expensive type of maintenance. Maintaining your unit and keeping it clean at all times will facilitate servicing.

Scheduled Maintenance

The maintenance schedule is based on normal operation of the unit. In the event unusual environmental operating conditions exist, the schedule should be adjusted accordingly.

Wiring Routing Clamps

Daily check for loose wire routing clamps. Clamps must be secure and properly mounted. Also check wiring for wear, deterioration and vibration abrasion.

Electrical Terminals

Check daily for evidence of arcing around electrical terminals.

Grounding Circuit

Daily check that the grounding circuit is in accordance with the Safety CE Directives, IEC 364-4-41 and the local code requirements. As a minimum, the copper wire size should be 10mm² from the grounding terminal, frame, generator and engine block.

Hoses

Each month it is recommended that the intake hoses from the air cleaner and all flexible hoses used for water and fuel be inspected for the following:

1. All rubber hose joints and the screw type hose clamps must be tight and the hoses showing no signs of wear, abrasion or deterioration.
2. All flexible hoses must be free of wear, deterioration and vibration abrasion. Routing clamps must be secure and properly mounted.

Wiring Insulation

Daily check for loose, or frayed wiring insulation or sleeving.

Fuel/Water Separator

Daily check for water in the fuel filter/water separator unit. Some engines have a translucent bowl for visual indication, and others have a drain valve below the primary element.

Every six months or 500 hours, or less if fuel is of poor quality or contaminated, replace the bowl element(s).

Air Vents

Daily clean the air vents of any obstruction or debris.

Air Cleaner

Proper maintenance of the air cleaner provides maximum protection against airborne dust. Squeeze the rubber valve (precleaner dirt dump periodically to ensure that it is not clogged).

To service the air cleaners, proceed as follows:

1. Remove filter element.
2. Inspect air cleaner housing for any condition that might cause a leak and correct as necessary.
3. Wipe inside of air cleaner housing with a clean, damp cloth to remove any dirt accumulation. This will permit better seal for gasket on filter element.
4. Install element.

The air cleaner assembly (housing) should be inspected every 3 months or 500 hours for any leakage paths.

Note: Make sure the inlet is free from obstruction.

Make sure the air cleaner mounting bolts and clamps are tight and the air cleaner is mounted securely. Check the air cleaner housing for dents or damage to the cleaner, which could lead to a leak.

Fasteners Torque Chart

All fasteners should be torqued in accordance to size and grade. See following inch torque chart, metric torque chart and wheel torque chart.

TABLE 1 INCH FASTENERS				
CAPSCREW OR NUT THREAD SIZE AND PITCH	NOMINAL DESIGN TORQUE			
	8AE J249 GRADE 5 (HEAD MARKING)		8AE J249 GRADE 8 (HEAD MARKING)	
	(Nm.)	(FT-LBF)	(Nm.)	(FT-LBF)
1/4 – 20	11	8	16	12
5/16 – 18	24	17	33	25
3/8 – 16	42	31	59	44
7/16 – 14	67	49	95	70
1/2 – 13	102	75	144	106
9/16 – 12	148	109	208	154
5/8 – 11	203	150	287	212
3/4 – 10	361	266	509	376

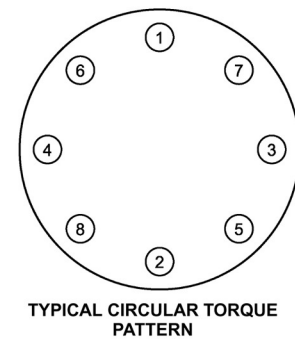
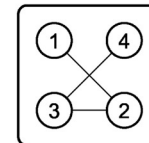
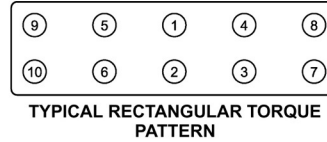









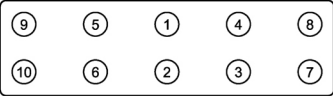
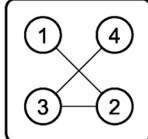

TABLE 2 METRIC FASTENERS						
CAPSCREW OR NUT THREAD SIZE AND PITCH	NOMINAL DESIGN TORQUE					
	PROPERTY GRADE 8.8 (HEAD MARKING)		PROPERTY GRADE 10.9 (HEAD MARKING)		PROPERTY GRADE 12.9 (HEAD MARKING)	
						
						
						
	(Nm.)	(FT-LBF)	(Nm.)	(FT-LBF)	(Nm.)	(FT-LBF)
M6 X 1.0	11	8	15	11	18	13
M8 X 1.25	26	19	36	27	43	31
M10 X 1.5	52	38	72	53	84	62
M12 X 1.75	91	67	126	93	147	109
M14 X 2	145	107	200	148	234	173
M16 X 2	226	166	313	231	365	270
M20 X 2.5	441	325	610	450	713	526



TYPICAL RECTANGULAR TORQUE PATTERN



TYPICAL SQUARE TORQUE PATTERN

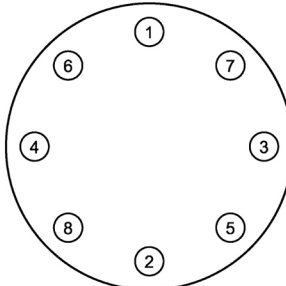

TYPICAL CIRCULAR TORQUE PATTERN

Wheel Torque Chart	
M12 bolts	Torque (ft-Lbs)
13" wheel	60-70
1/2" lug nuts	
13" wheel	80-90
15" wheel	105-115
16" wheel	105-115
16.5" wheel	105-115
5/8" lug nuts	
16" wheel	190-210
17.5" wheel	190-210

Engine Radiator

Check the coolant level in the radiator. The coolant must cover the tubes in the top tank (approximately 1 inch high on a clean measuring rod, stuck down filler neck).



Remove cap slowly to relieve pressure from HOT radiator. Protect skin and eyes. Hot water or steam and chemical additives can cause serious personal injury.

The engine coolant system is normally filled with a 50/50 mixture of water and ethylene glycol. This permanent type anti-freeze contains rust inhibitors and provides protection to -35°F (-37°C). The use of such a mixture is recommended for both summer and winter operation. When using water alone, be sure to add a reputable brand of rust inhibitor to prevent internal corrosion.

It is recommended to test the freezing protection of the coolant every six months or prior to freezing temperatures. Replenish with a fresh mixture every twelve months.

Each month, inspect the radiator exterior for obstructions, dirt and debris. If present, blow water or compressed air containing a non-flammable solvent between the fins in a direction opposite the normal air flow. Should the radiator be clogged internally, reverse flushing, using a commercial product and the supplier's recommended procedure, may correct the problem.

Emergency Stop Switch

Each month, check the operation of the emergency stop switch. Running with no electrical loads and the main breaker "ON", press the EMERGENCY STOP SWITCH. The unit should shutdown immediately and the main breaker should trip with cranking disabled. Emergency Stop Switch must be reset (pull to unlatch) for operation.

Engine Protection Shutdown System

The operation of the engine protection shutdown system should be checked every month or, whenever it appears not to be operating properly. The three devices involved in this protective shutdown system are the engine coolant high temperature switch/sensor, the engine oil pressure switch/sensor and the low fuel switch.

The engine oil pressure switch/sensor prevents the engine from operating with low oil pressure. Once a month, remove a wire from the engine oil pressure switch/sensor to check the shutdown system for proper operation. Do the same for the wire on the engine temperature switch/sensor.

High Containment Fluid Alarm System

The operation of the high containment fluid alarm system should be checked every 3 months or, whenever it appears not to be operating properly.

The level switch is located at the lower end of a pipe at the bottom of the containment tank.

Test the switch by unfastening the u-bolts holding the pipe, and then inverting the pipe to allow the switch float to fall.

The "High Containment Level" LED should illuminate. Replace any defective switch.

Drain the containment area as required, by lowering a suction hose into the containment basin at the rear of the unit, (just behind the instrument panel).

ADJUSTMENT INSTRUCTIONS and TESTING PROCEDURES

ACCESSING COMPARTMENT

1. Disconnect all electrical loads to the unit.



High Voltage is present in alternator and control compartments when engine is running. Battery voltage is present whenever battery is connected. ****Always use Doosan Replacement parts!****

2. With engine stopped, remove the plate on the left side or front of the alternator junction box.
3. Locate voltage regulator.

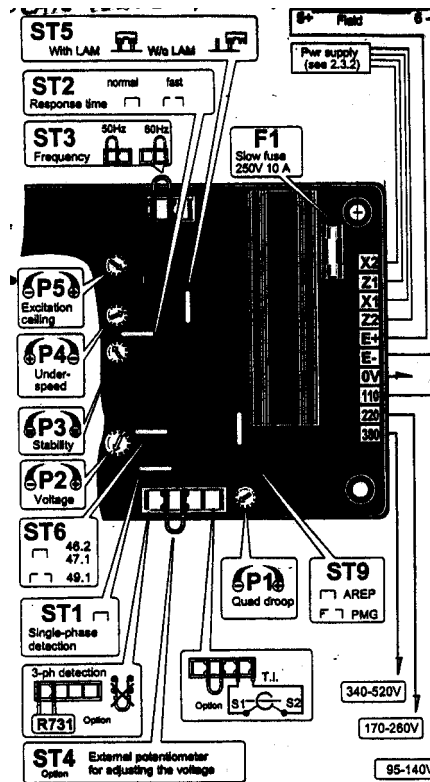

VOLTAGE REGULATOR ADJUSTMENT

Refer to ACCESSING COMPARTMENT Section and Figure 8-1 for locations.

1. Disconnect all electric loads. Stop Engine. Turn main breaker OFF.
2. Adjust "Voltage" POT(P2) on regulator to full counterclockwise position.
3. Adjust "Voltage" POT on control panel to full clockwise position.
4. Start unit.
5. Verify generator frequency to 52-53 Hz at no load. If adjustment is required, see procedures (50-50.5 Hz if electronic speed control).
6. Adjust "VOLTAGE" POT(P2) on the regulator to read 440V on AC voltmeter.
7. Adjust "Stability" POT(P3) counter clockwise until the AC volts within ± 1 volt. Then turn the adjusting "Stability" POT (P3) some 5-10 degrees clockwise.
8. Adjust "Voltage" POT on control panel to read 400V on AC voltmeter.
9. Stop Generator Set.

POWER BYPASS SWITCH FOR ENGINE ECU SERVICE

Push the Power Bypass Switch to temporarily apply power to the engine ECU during engine computer diagnostics on a stopped engine. The switch is located on the side of the engine next to the Can Bus diagnostic connector.

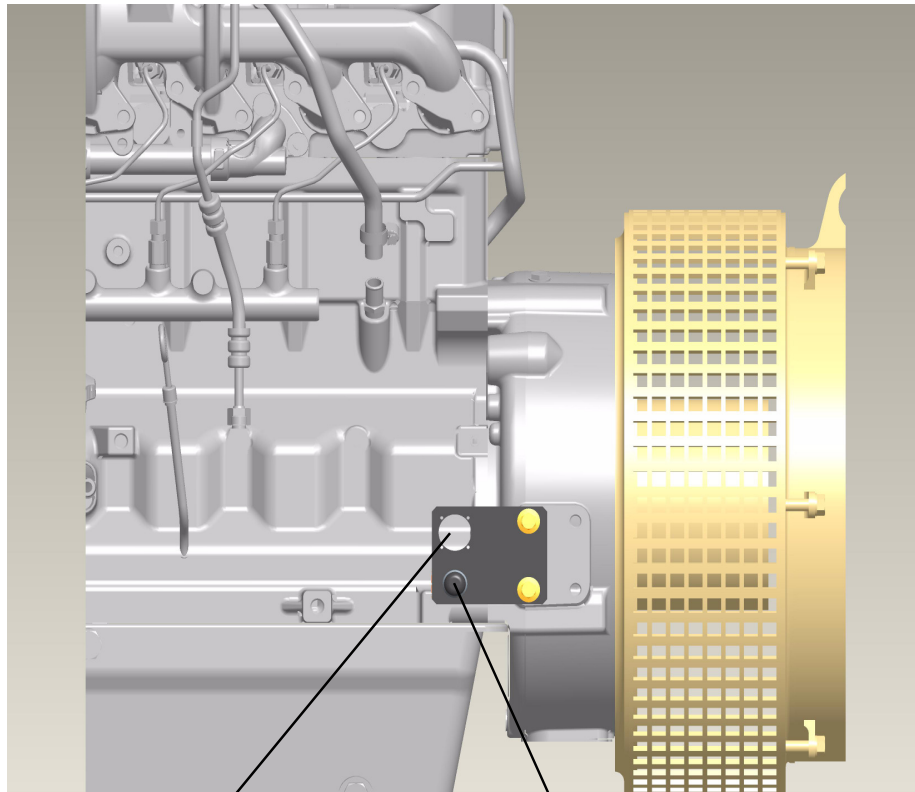

Can Bus Diagnostic Connector

Power Bypass Switch



Alternator Installation and Maintenance

Leroy Somer Alternator

LSA 42.2/43.2/44.2/46.2/47.2 - 4 POLE

This section concerns the alternator used in the generator set, which you have just purchased.

We wish to draw your attention to the contents of this maintenance section. By following certain important points during installation, use and servicing of your alternator, you can look forward to many years of trouble-free operation.

Our alternators comply with most international standards and are compatible with:

- The recommendations of the International Electrotechnical Commission IEC 34-1, (EN60034).
- The recommendation of the International Standards Organization ISO 8528.
- The European Community directive on Electromagnetic Compatibility (EMC) 89/336/EEC).
- The European Community directives 73/23/EEC and 93/68/EEC (Low Voltage Directive).

The are CE marked with regard to the LVD (Low Voltage Directive) in their role as a machine component. A declaration of incorporation can be supplied on request.

SAFETY MEASURES

Before using your machine for the first time, it is important to read the whole of this installation and maintenance manual.

All necessary operations and interventions on this machine must be performed by a qualified technician.

Our technical support service will be pleased to provide any additional information you may require.

The various operations described in this manual are accompanied by recommendations or symbols to alert the user to potential risk of accident. It is vital that you understand and take notice of the different warning symbols used.



Warning symbol for an operation capable of damaging or destroying the machine or surrounding equipment.

 **WARNING**

Safety symbol for an operation capable of damaging or destroying the machine or surrounding equipment or danger to personnel.



Safety symbol for electrical danger to personnel.



Identification





The alternator is identified by means of a nameplate glued to the frame. Make sure that the nameplate on the machine conforms to your order. The machine name is defined according to various criteria (see below).

Example of description: LSA 43.2 M45 J6/4

- LSA: Name used in the PARTNER range
- M: Marine
- C: Cogeneration
- T: Telecommunications
- 43.2: Machine Type
- M45: Model
- J: Excitation System (C: AREP/J: SHUNT or PMG/E: COMPOUND)
- 6/4: Winding number/number of poles

Nameplate

So that you can identify your machine quickly and accurately, we suggest you fill in its specifications on the nameplate below.

 ALTERNATEURS PARTNER ALTERNATORS																																																																																					
<table border="1"> <tr> <td>LSA</td> <td>_____</td> <td>Date</td> <td>_____</td> </tr> <tr> <td>N°</td> <td>_____</td> <td>Hz</td> <td>_____</td> </tr> <tr> <td>Min-1/R.P.M.</td> <td>_____</td> <td>Protection</td> <td>_____</td> </tr> <tr> <td>Cos φ / P.F.</td> <td>_____</td> <td>Cl. ther. / Th. class</td> <td>_____</td> </tr> <tr> <td>Régulateur/A.V.R.</td> <td colspan="3">_____</td> </tr> <tr> <td>Altit. ≤</td> <td>_____</td> <td>Masse / Weight</td> <td>_____</td> </tr> <tr> <td>Rit AV/D.E bearing</td> <td colspan="3">_____</td> </tr> <tr> <td>Rit AR/N.D.E bearing</td> <td colspan="3">_____</td> </tr> <tr> <td>Graisse / Grease</td> <td colspan="3">_____</td> </tr> <tr> <td>Valeurs excit / Excit. values</td> <td colspan="3">_____</td> </tr> <tr> <td>en charge / full load</td> <td colspan="3">_____</td> </tr> <tr> <td>à vide / at no load</td> <td colspan="3">_____</td> </tr> </table>	LSA	_____	Date	_____	N°	_____	Hz	_____	Min-1/R.P.M.	_____	Protection	_____	Cos φ / P.F.	_____	Cl. ther. / Th. class	_____	Régulateur/A.V.R.	_____			Altit. ≤	_____	Masse / Weight	_____	Rit AV/D.E bearing	_____			Rit AR/N.D.E bearing	_____			Graisse / Grease	_____			Valeurs excit / Excit. values	_____			en charge / full load	_____			à vide / at no load	_____			<table border="1"> <tr> <th colspan="4">PUISSANCE / RATING</th> </tr> <tr> <td>Tension Voltage</td> <td>_____</td> <td>_____</td> <td>V</td> </tr> <tr> <td>Connex.</td> <td>_____</td> <td>_____</td> <td>Ph.</td> </tr> <tr> <td>Continue</td> <td>_____</td> <td>_____</td> <td>kVA</td> </tr> <tr> <td>Continuous 40°C</td> <td>_____</td> <td>_____</td> <td>kW</td> </tr> <tr> <td></td> <td>_____</td> <td>_____</td> <td>A</td> </tr> <tr> <td>Secours</td> <td>_____</td> <td>_____</td> <td>kVA</td> </tr> <tr> <td>Std by</td> <td>_____</td> <td>_____</td> <td>kW</td> </tr> <tr> <td>27°C</td> <td>_____</td> <td>_____</td> <td>A</td> </tr> </table>	PUISSANCE / RATING				Tension Voltage	_____	_____	V	Connex.	_____	_____	Ph.	Continue	_____	_____	kVA	Continuous 40°C	_____	_____	kW		_____	_____	A	Secours	_____	_____	kVA	Std by	_____	_____	kW	27°C	_____	_____	A
LSA	_____	Date	_____																																																																																		
N°	_____	Hz	_____																																																																																		
Min-1/R.P.M.	_____	Protection	_____																																																																																		
Cos φ / P.F.	_____	Cl. ther. / Th. class	_____																																																																																		
Régulateur/A.V.R.	_____																																																																																				
Altit. ≤	_____	Masse / Weight	_____																																																																																		
Rit AV/D.E bearing	_____																																																																																				
Rit AR/N.D.E bearing	_____																																																																																				
Graisse / Grease	_____																																																																																				
Valeurs excit / Excit. values	_____																																																																																				
en charge / full load	_____																																																																																				
à vide / at no load	_____																																																																																				
PUISSANCE / RATING																																																																																					
Tension Voltage	_____	_____	V																																																																																		
Connex.	_____	_____	Ph.																																																																																		
Continue	_____	_____	kVA																																																																																		
Continuous 40°C	_____	_____	kW																																																																																		
	_____	_____	A																																																																																		
Secours	_____	_____	kVA																																																																																		
Std by	_____	_____	kW																																																																																		
27°C	_____	_____	A																																																																																		
   Conforme à C.E.I 34-1 (1994). According to I.E.C 34-1 (1994).		Made by Leroy Somer - 1 024 930/b																																																																																			

Voltage Regulation - AREP System with R438 AVR (42.2, 43.2, 44.2)

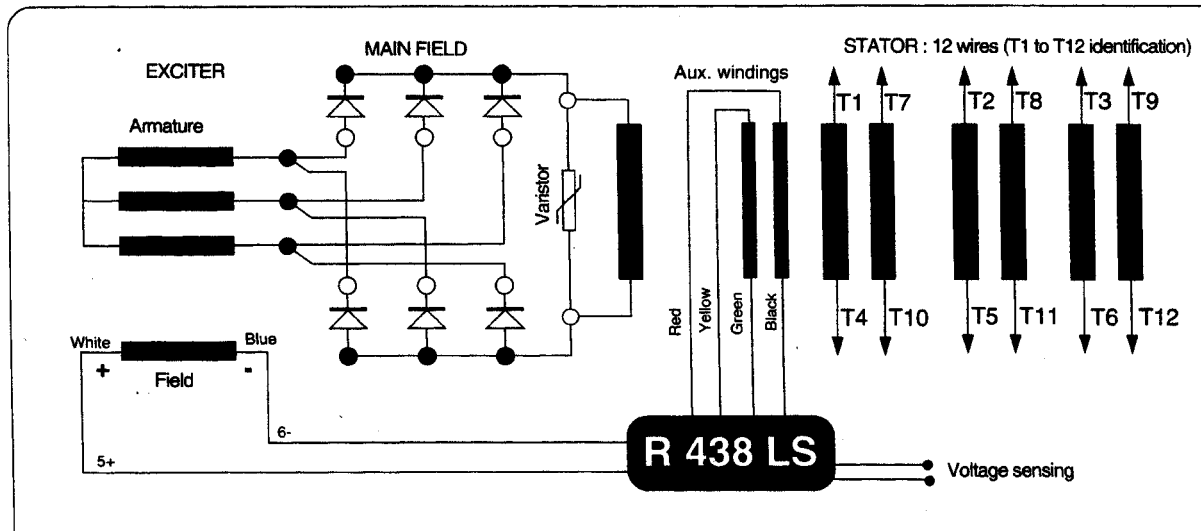

AREP Excitation System

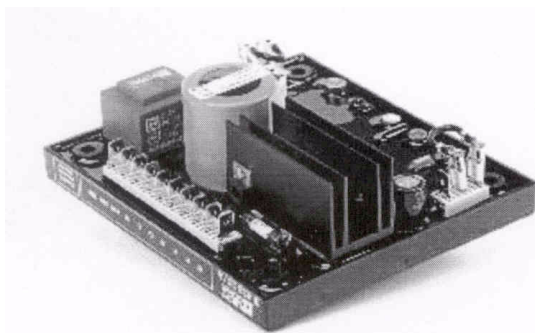

With AREP excitation, the R438 electronic AVR is powered by two auxiliary windings which are independent of the voltage sensing circuit. The first winding has a voltage in proportion to that of the alternator (shunt characteristic), the second has a voltage in proportion to the stator current (compound characteristic: booster effect). The power supply voltage is rectified and filtered before being used by the AVR monitoring transistor. This principle ensures that regulation is not affected by distortions generated by the load.

R 438 LS Regulator

- Short-circuit current = 3 x IN for 10 seconds
- Short-circuit current = 3 x IN for 10 seconds
- Standard power supply; 2 auxiliary windings
- Shunt power supply; max 4SV -50/60 Hz
- Rated overload current: 8A-10S
- Electronic protection (overload, short-circuit opening on voltage detection): excitation ceiling current for 10 seconds then return to approx. 1A

The alternator must be stopped (or the power switched off) in order to reset the protection.

- Fuse F1 on input side (X1, X2)
- Fuse F2 on output side (E+, E-)
- Voltage detection: 5 VA isolated via transformer. 0-110V terminals = 95 to 140V, 0-220V terminals = 170 to 260V, 0-380V terminals = 340 to 520V
- Voltage regulation $\pm\%$
- Rapid or normal response time via strap ST2
- Voltage adjustment via potentiometer P2. Other voltages via step down transformer.
- Current detection: (parallel operation): C.T. 2.5VA cl1, secondary 1A (Option)
- Quadrature droop adjustment via potentiometer P1
- Underspeed protection (U/f) and LAM: frequency threshold adjustable via potentiometer P4.
- Potentiometer P5, Max. excitation current adjustment via P5: 4.5 to 10A
- 50/60 Hz selection via strap ST3.

R438 A.V.R Options

- **Current transformer** for parallel operation.
- Remote voltage adjustment potentiometer: 470 Q, 0.5 W min: adjustment range :t 5% (range limited via internal voltage potentiometer P2).
- Remove ST4 to connect the potentiometer. (A 1 k potentiometer can also be used to extend the adjustment range).

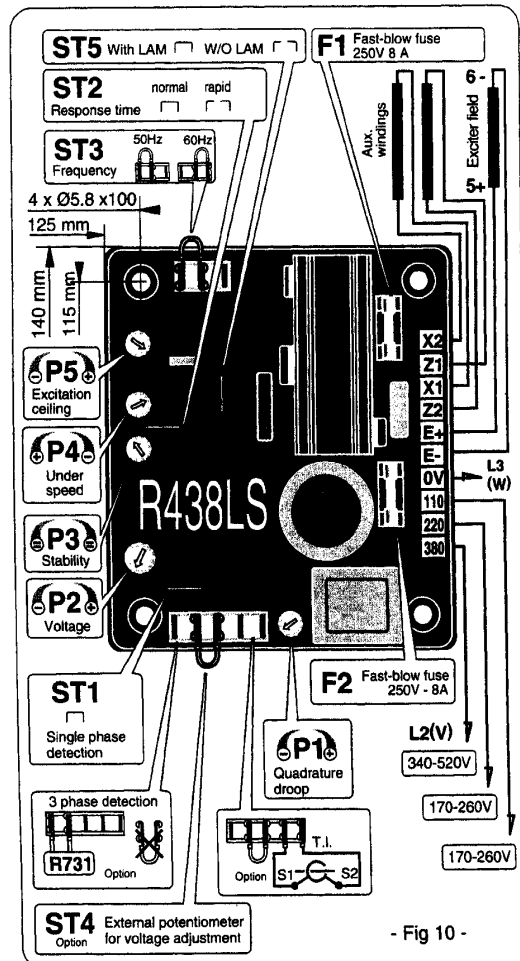

LAM Characteristics

The LAM system is integrated as standard in the R438 LS regulator.

Role of the "LAM" (Load Adjustment Module):

- On load impact, the rotation speed of the generator set decreases. When it passes below the preset frequency threshold, the "LAM" causes the voltage to drop by approximately 15% and consequently the amount of active load applied is reduced by approximately 25%, until the speed reaches its rated value again. Hence the "LAM" can be used either to reduce the speed variation (frequency) and its duration for a given applied load, or to increase the applied load possible for one speed variation (turbo-charged engine). To avoid voltage oscillations, the trip threshold for the "LAM" function should be set approximately 2 Hz below the lowest frequency in steady state.
- LAM: action eliminated by cutting strap ST5.

Typical effects of the "LAM" with a diesel engine (Figure 12).

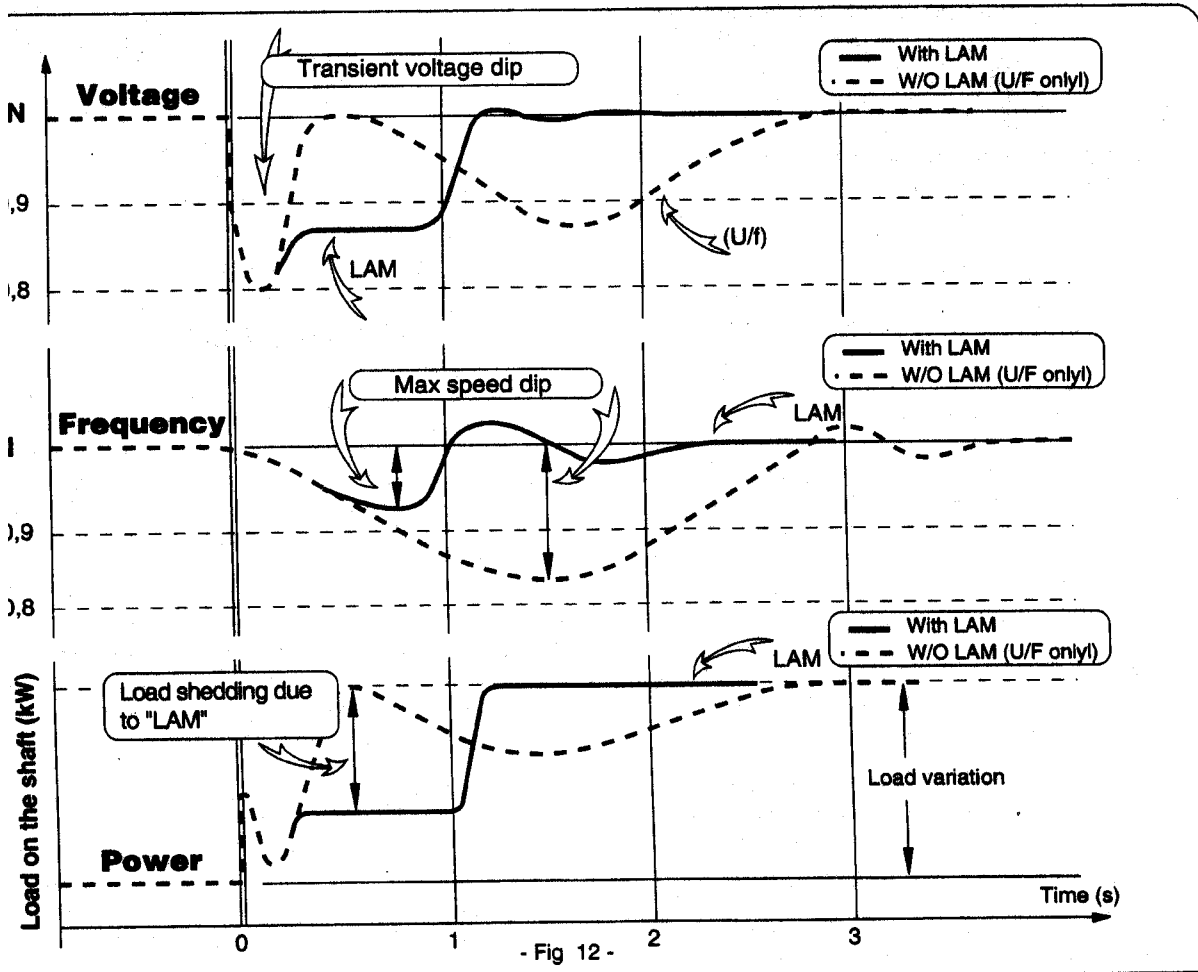

INSTALLATION - COMMISSIONING

Assembly

All mechanical handling operations must be undertaken using approved equipment.

While being handled, the machine should remain horizontal (when travelling bar removed).

Handling

The generously sized lifting rings are for handling the alternator alone. They must not be used to lift the alternator alone. They must not be used to lift the genset. Choose a lifting system which respects the positioning of the rings (See Fig.13).

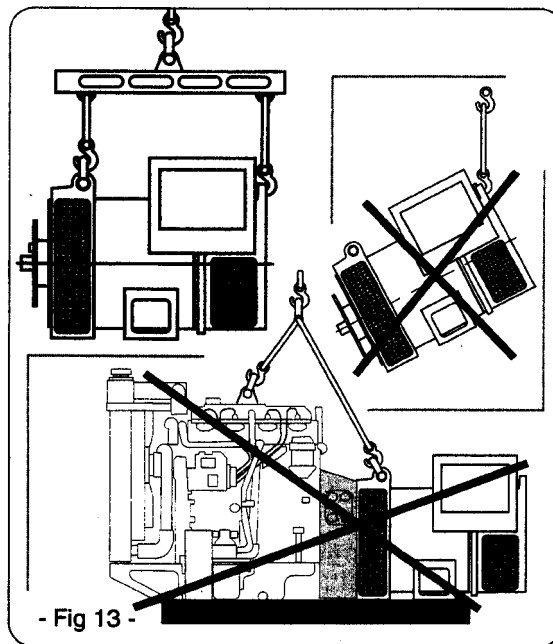

Coupling (Single Bearing Alternator)

Before coupling to the prime mover, check that both are compatible by:

- Undertaking a torsional analysis of the transmission.
- Checking the dimensions of the flywheel and its housing, the flange, coupling discs and offset.

WARNING

When coupling the alternator to the prime mover, the holes of the coupling discs should be aligned with the flywheel holes by cranking the engine.

Do not use the alternator fan to turn the rotor.

Tighten the coupling discs screws to the recommended torque and check that there is lateral play on the crankshaft.

Inspection Prior to First Use

Electrical checks



Under no circumstances should an alternator, new or otherwise, be operated if the isolation is less than 1 megohm for the stator and 100,000 ohms for the other windings.

There are three possible methods for restoring the above minimum values.

- a) Dry out the machine for 24 hours in a drying oven at a temperature of approximately 110°C.
- b) Blow hot air into the air input, having made sure that the machine is rotating with the exciter field disconnected.
- c) Run in short-circuit mode (disconnect the AVR).
 - Short-circuit the output phases using connections capable of supporting the rated current (try not to exceed 6 A/mm²).
 - Insert a clamp ammeter to monitor the current passing through the short-circuit connections.
 - Connect a 48 Volt battery in series with a rheostat of approximately 10 ohms (50 Watts), to the exciter field terminals, respecting the polarity.
 - Connect a 48 Volt battery in series with a rheostat of approximately 10 ohms (50 Watts), to the exciter field terminals, respecting the polarity.
 - Open fully all the alternator orifices.
 - Run the alternator at rated speed. Adjust the exciter field current using the rheostat to obtain the rated output current in the short-circuit connections.

Note: Prolonged standstill: In order to avoid these problems, we recommend the use of space heaters, as well as turning over the machine from time to time.



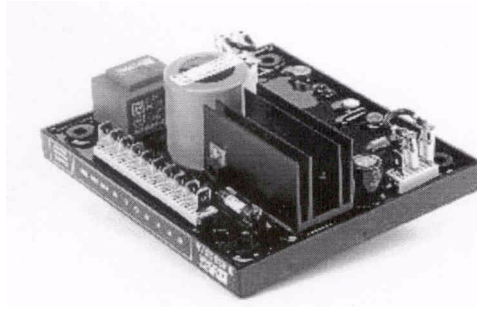

Space heaters are only really effective if they are working continuously while the machine is stopped.

R438 Adjustments (AREP System)

- a) Initial potentiometer settings (see table on following page).
 - remote voltage adjustment potentiometer: centre (ST4 strap removed)
- b) Install a D.C. analogue voltmeter (needle dial) cal. 50V on terminals E+, E- and an A.C. voltmeter cal. 300 - 500 or 1000V on the alternator output terminals.
- c) Make sure that the ST3 strap is positioned on the desired frequency (50 or 60 Hz).
- d) Voltage potentiometer P2 at minimum, fully to anti-clockwise.
- e) Turn the V/Hz potentiometer P4, fully to clockwise.
- f) Stability potentiometer P3 approximately 1/3 of travel anti-clockwise.
- g) Start the engine and set its speed to a frequency of 48 Hz for 50 Hz, or 58 for 60 Hz.
- h) Adjust the output voltage to the desired value using P2.
 - rated voltage UN for solo operation (eg. 400 V)
 - or UN + 2 to 4% for parallel operation with C.T. (eg. 410V -)

If the voltage oscillates, use P3 to make adjustments (try both directions) observing the voltage between E+ and E- (approx. 10V D.C.). The best response times are obtained at the limit of the instability. If no stable position can be obtained, try cutting or replacing the ST2 strap (normal/rapid).
- i) Check LAM operation: STS closed
- j) Turn potentiometer P4 slowly anti-clockwise until there is a significant voltage drop (approx. 15 %).
- k) Vary the frequency (speed) of both parts between 48 or 58 Hz according to the operating frequency, and check the change in voltage previously observed (-15%).

l) Readjust the speed of the unit to its rated no-load value.

Action	Factory adjust.	Pot.
Voltage minimum fully CCW	400V - 50 Hz (0 - 380 V)	
Stability	Not adjusted (middle)	
Threshold/LAM or U/F Threshold for underspeed protection U/f and LAM function	ST3 on 50 Hz (factory=48 Hz) ST3 on 60 Hz (factory=58 Hz)	
Quadrature voltage droop (Parallel operation with C.T.) - No droop fully CCW	Not adjusted (fully CCW)	
Ceiling excitation current Excitation current and short circuit current limitation, minimum fully CCW	10 A maximum	

SERVICING-MAINTENANCE

Safety Measures



Servicing or troubleshooting must be carried out strictly in accordance with instructions so as to avoid the risk of accidents and to maintain the machine in its original state.



All such operations performed on the alternator should be undertaken by personnel with training of electrical and mechanical components.

Before any intervention on the machine, ensure that it cannot be started by a manual or automatic system and that you have understood the operating principles of the system.

Checks after startup

After approximately 20 hours of operation, check that all fixing screws on the machine are still tight, plus the general state of the machine and the various electrical connections in the installation.

Cooling circuit

It is advisable to check that circulation of air is not reduced by partial blocking of the suction and discharge louvres: mud, fibre, grease, etc.

Bearings

The bearings are greased for life: approximate life of the grease (depending on use) = 20,000 hours or 3 years. Monitor the temperature rise in the bearings, which should not exceed 60 °C above the ambient temperature. Should this value be exceeded, the machine must be stopped and checks carried out.

Electrical servicing

Cleaning product for the windings

WARNING

Do not use: Trichlorethylene, perchlorethylene, trichloroethane and any alkaline products.

Certain strictly defined pure volatile degreasing products can be used, such as:

- Normal petrol (without additives)
- Toluene (slightly toxic); flammable
- Benzene (or benzine, toxic); flammable
- Ciclohexare (non toxic); flammable

Cleaning the stator, rotor, exciter and diode bridge

The isolating components and the impregnation system are not at risk of damage from solvents (see the list of authorized products above).

Avoid letting the cleaning product run into the slots.

Apply the product with a brush, sponging frequently to avoid accumulation in the housing. Dry the winding with a dry cloth. Let any traces evaporate before reassembling the machine.

After cleaning the alternator it is essential to check the isolation of the windings.

Fault detection

If, when first commissioned, the alternator does not work normally, the source of the malfunction must be identified.

To do this, check that:

- the protective devices are fitted correctly
- all connections comply with the diagrams in the manuals supplied with the machine
- the speed of the unit is correct. Repeat the operations instructions.

Mechanical Servicing

Cleaning the machine using a water spray or a high-pressure washer is strictly prohibited. Any problems arising from such treatment are not covered by our warranty.

The machine should be cleaned with a degreasing agent, applied using a brush. Check that the degreasing agent will not affect the paint. Compressed air should be used to remove any dust. If filters have been added to the machine after manufacturer and do not have thermal protection, the service personnel should clean the air filters periodically and systematically, as often as necessary (everyday in very dusty atmospheres). Cleaning can be performed using water for dry dust or in a bath containing soap or detergent in the case of greasy dust. Petrol or chloroethylene can also be used. After cleaning the alternator, it is essential to check the winding insulation.

Mechanical Defects

Mechanical defects	
Bearing Defect	Action
Excessive overheating of one or both bearings (temp of bearings over 80 °C) (With or without abnormal bearing noise)	If the bearing has turned blue or if the grease has turned black, change the bearing.
	Bearing race badly locked (moving in its housing)
Overheating	Action
Excessive overheating of alternator frame (temperature rise of more than 40 °C above ambient)	Air flow (inlet-outlet) partially clogged or hot air is being recycled either from alternator or prime mover.
	Alternator is functioning at too high a voltage (over 105% of rated voltage on load).
	Alternator overloaded
Vibration Problem	Action
Too much vibration	Misalignment (coupling)
	Defective mounting or play in coupling
	Incorrect balancing of shaft (Engine-Alternator)
Excessive vibration and humming noise coming from the alternator	Three phase alternator is single phase loaded in excess of acceptable level.
	Short circuit in the alternator stator
Abnormal Noises	Action
Alternator damaged by a significant impact which is followed by humming and vibration	System short circuit
	MIS paralleling
	Possible consequences (according to the seriousness of the above faults):
	Broken or damaged coupling
	Broken or bent shaft end
	Shifting and short circuit of main field rotor
	Fractured fan or coming loose on shaft
Blown rotating diodes, or and A.V.R	

Electrical Faults

Fault	Action	Symptoms	Cause
No voltage at no load or startup	Connect a battery of 4 to 12 volts to terminals E+ or E- respecting the polarity on the A.V.R. for 2 to 3 seconds	- The alternator builds up and voltage is correct when the battery is removed.	- Lack of residual magnetism
		The alternator builds up but voltage does not reach nominal value when the battery is removed.	- Check the connections of the sending leads to the A.V.R. - Faulty rotating diode - Short-circuit on rotor windings
		The alternator builds up but voltage collapses when the battery is removed.	- Faulty A.V.R. - Exciter field short-circuited or open circuit (check windings) - Main field winding open circuit (check resistance).
Voltage too low	Check the prime mover speed	Correct speed	- Check A.V.R. connections (possible AVR failure) - Exciter field short-circuited - Rotating diode(s) burnt out. - Main field rotor short-circuited - Check the resistance.
		Speed too low	Increase the speed of primer mover. (Do not touch the AVR voltage pot. (P2) before running at the correct speed).
Voltage too high	Adjust potentiometer voltage	No adjustment of voltage, measure voltage E+/E- on AVR	Voltage between E+ and E- > 12V or AVR faulty
Voltage oscillations	Adjust the stability potentiometer on A.V.R	If no effect: change recovery mode normal/rapid (ST2) R438 or R448 only	Check speed for possible cyclic irregularity Loose connections Faulty A.V.R. Speed below nominal on load (or LAM set too high)
Voltage correct on no load too low on load (*)	Run on no-load and check voltage between E+ and E-	Voltage between E+ and E- <6V (DC) Voltage between E+ and E- >10V (DC)	Check speed (or LAM on R438 set too high) Faulty rotating diodes faulty Short circuit in the main field. Check resistance. Faulty exciter armature. Check resistance.
Voltage collapses during normal operation (**)	Check the AVR, the surge suppressor, the rotating diodes and replace any defective part	The output voltage does not return the rated value	Exciter winding open circuit Faulty exciter armature Faulty AVR Main field rotor winding open circuit or short circuit

 **WARNING**

***During single-phase operation, check that the sensing wires from the AVR are connected to the correct output terminals.**

 **WARNING**

**** The AVR internal protection may cut in (overload lost connection, short circuit).**

Checking the winding

You can check the winding insulation by performing a high voltage test. In this case you must disconnect all AVR wires.

During this procedure, make sure that the alternator is disconnected from any external load and inspect the terminal box to check that the connections are fully tightened.

- Stop the unit, disconnect and disconnect the leads E+ (5+) and E- (6-) from the terminals located on the side of the voltage regulator (AVR).
- Using jumper wires and a momentary normally open switch, connect the E+ (5+) lead to one side of the switch and connect the other side of the switch to the positive (+) terminal of a 6 VDC dry cell battery. Then take the E- (6-) lead and ground it to the frame of the unit, and ground the negative (-) terminal of the battery to the unit.
- Run the unit at its rated speed.
- Connect a voltmeter to the direct hookups and shut the output breaker and the momentarily shut switch connected to the E+ (5+) lead and check the output voltage on the voltmeter. If the output voltage of the alternator is greater than its normal value then the machine is in good working order. The fault therefore comes from the AVR or its associated wiring (i.e. sensing, auxiliary windings).

Checking the diode bridge



Damage caused to the AVR in such conditions is not covered by our warranty.

LSA 42.2 diode bridge

Anode **A**  Cathode **C**

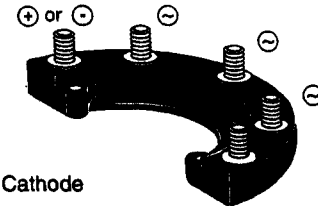
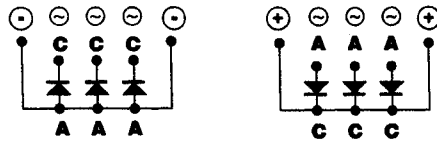

A diode in good condition enables the current to flow in only one direction from Anode to Cathode

- Fig 21 -

LSA 43.2 / 44.2 Diode bridge

Anode **A**  Cathode **C**

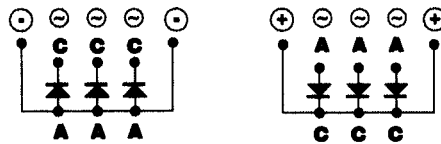

A diode in good working condition allows the current to flow in only one direction, from anode to cathode.

A diode in good working condition allows the current to flow in only one direction, from anode to cathode.

TECHNICAL CHARACTERISTICS

Electrical Characteristics

The PARTNER alternator is a machine without slip rings and revolving field brushes, wound as "2/3 pitch"; 12-wire, with class H insulation and a field excitation system available in either "SHUNT" or 'AREP" version. Interference suppression conforms with standard EN 55011, group 1, Class B.

Options: Stator temperature detection probes, space heaters.

Mechanical Characteristics

- Steel Frame
- End shields in cast iron or aluminium
- Ball bearings greased for life
- Mounting arrangement
- MD 35 STANDARD: single bearing, with standard feet and SAE coupling discs
- B 34 STANDARD: two bearing feet mounted with standard bare shaft key wayed
- Drip-proof machine, self-cooled
- Degree of protection: IP 23

Options-Air input filter, air output labyrinth cowling

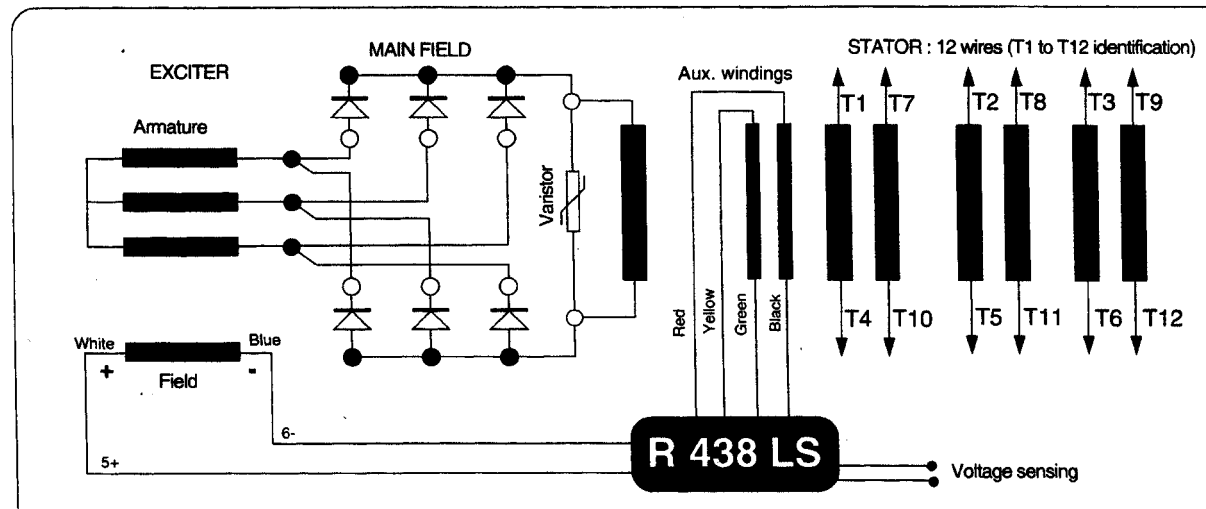

AREP Field Excitation System

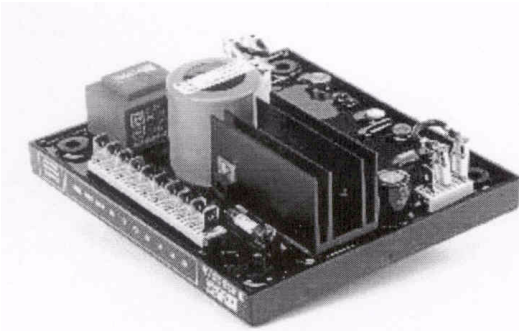

With AREP excitation, the R438 electronic AVR is powered by two auxiliary windings which are independent of the voltage sensing circuit. The first winding has a voltage in proportion to that of the alternator (shunt characteristic), the second has a voltage in proportion to the stator current (compound characteristic: booster effect). The power supply voltage is rectified and filtered before being used by the AVR monitoring transistor. This principle ensures that regulation is not affected by distortions generated by the load.

R 438 LS Regulator

- Short-circuit current = 3 x I_N for 10 seconds
- Short-circuit current = 3 x I_N for 10 seconds
- Standard power supply; 2 auxiliary windings
- Shunt power supply; max 4SV -50/60 Hz
- Rated overload current: 8A-10S
- Electronic protection (overload, short-circuit opening on voltage detection): excitation ceiling current for 10 seconds then return to approx. 1A

The alternator must be stopped (or the power switched off) in order to reset the protection.

- Fuse F1 on input side (X1, X2)
- Fuse F2 on output side (E+, E-)
- Voltage detection: 5 VA isolated via transformer. 0-110V terminals = 95 to 140V, 0-220V terminals = 170 to 260V, 0-380V terminals = 340 to 520V
- Voltage regulation ±%
- Rapid or normal response time via strap ST2
- Voltage adjustment via potentiometer P2. Other voltages via step down transformer.
- Current detection: (parallel operation): C.T. 2.5VA cl1, secondary 1A (Option)
- Quadrature droop adjustment via potentiometer P1
- Underspeed protection (U/f) and LAM: frequency threshold adjustable via potentiometer P4.
- Max. excitation current adjustment via P5: 4.5 to 10A
- Potentiometer P5 , Max. excitation current adjustment 4.5 to 8A.
- 50/60 Hz selection via strap ST3.

R438 A.V.R Options

- **Current transformer** for parallel operation.
- Remote voltage adjustment potentiometer: 470 Q, 0.5 W min: adjustment range :t 5% (range limited via internal voltage potentiometer P2). Remove ST4 to connect the potentiometer. (A 1 k potentiometer can also be used to extend the adjustment range.)

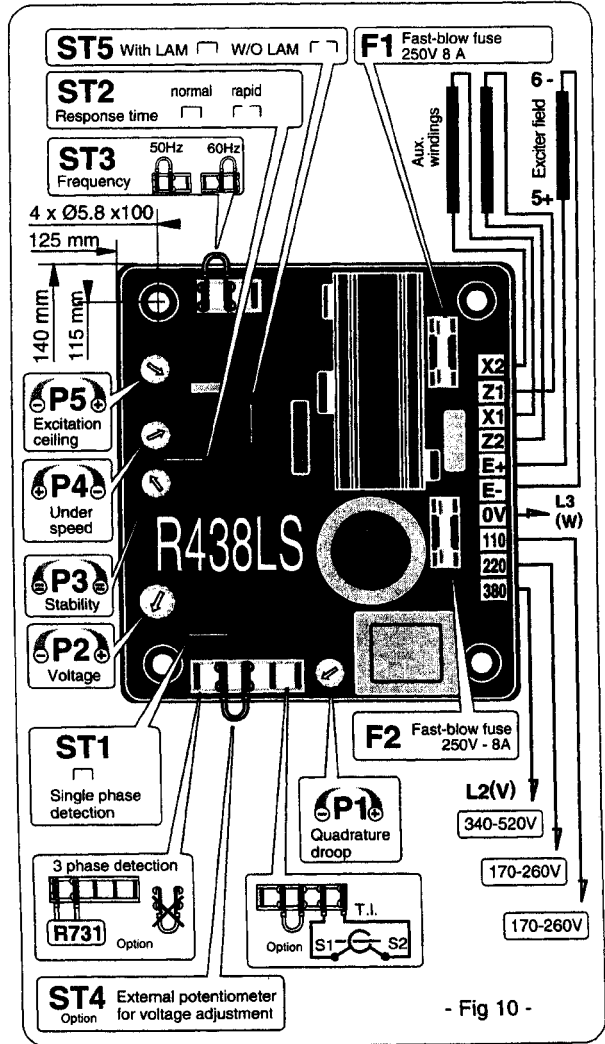

LAM Characteristics

The LAM system is integrated as standard in the R438 LS regulator.

Role of the "LAM" (Load Adjustment Module):

- On load impact, the rotation speed of the generator set decreases. When it passes below the preset frequency threshold, the "LAM" causes the voltage to drop by approximately 15% and consequently the amount of active load applied is reduced by approximately 25%, until the speed reaches its rated value again. Hence the "LAM" can be used either to reduce the speed variation (frequency) and its duration for a given applied load, or to increase the applied load possible for one speed variation (turbo-charged engine). To avoid voltage oscillations, the trip threshold for the "LAM" function should be set approximately 2 Hz below the lowest frequency in steady state.
- LAM: action eliminated by cutting strap ST5.

Typical effects of the "LAM" with a diesel engine (Figure 12).

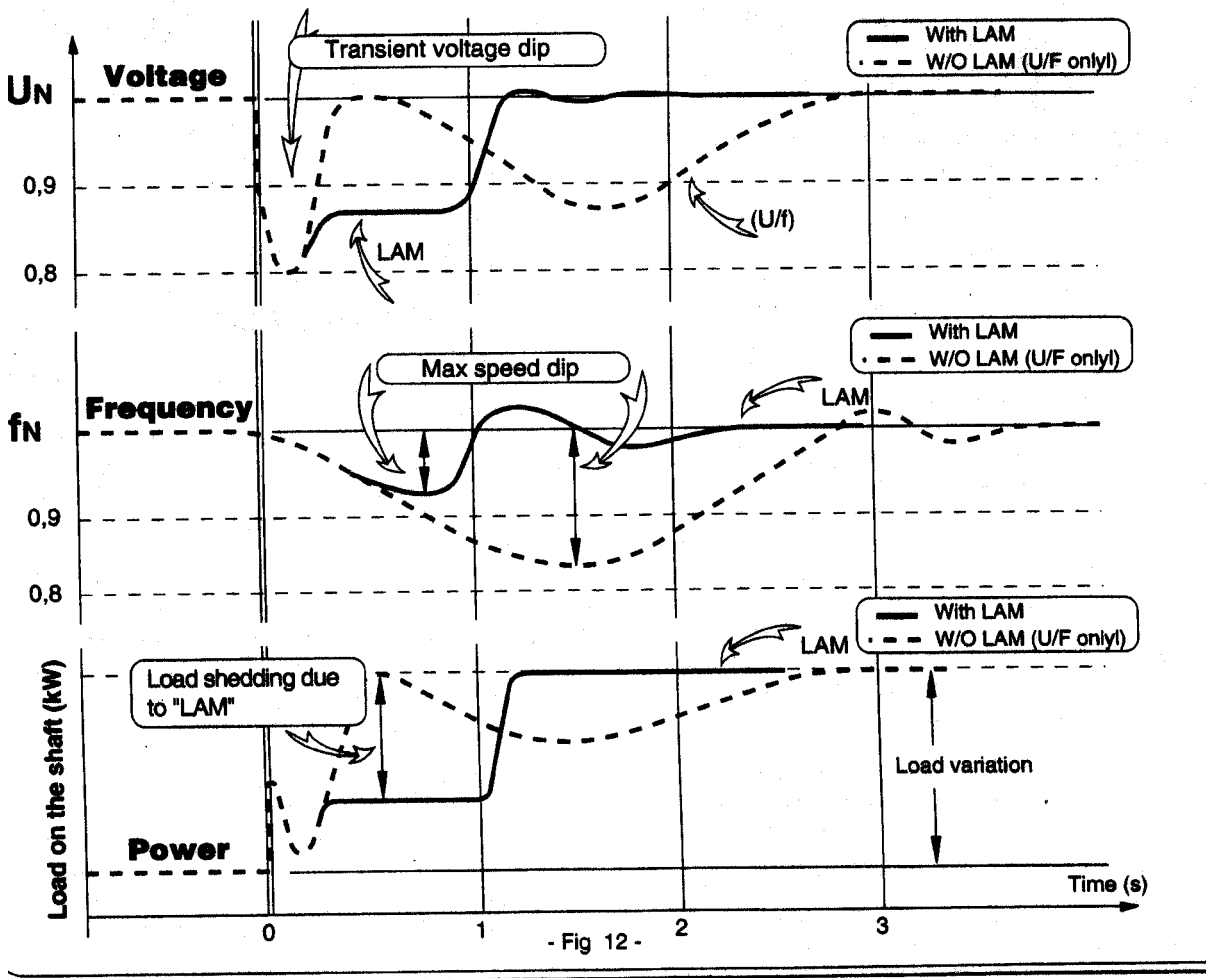

Dismantling reassembly



During the warranty period, this operation should only be carried out in a LEROY SOMER approved workshop or in our factory, otherwise the warranty may be invalidated.

The machine must be horizontal when handled (when travelling bar removed). See fig 23.

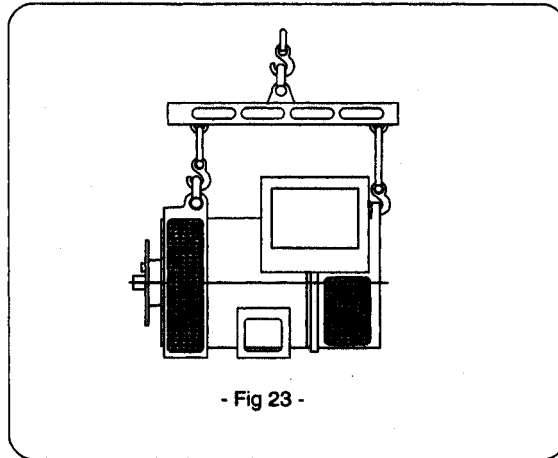

Tools Required

To fully dismantle the machine, we recommend you have the tools listed below:

1. Ratchet spanner + extension
2. Torque wrench
3. 7 mm flat spanner
4. 8 mm flat spanner
5. 10 mm flat spanner
6. 12 mm flat spanner
7. 8 mm socket
8. 10 mm socket
9. 13 mm socket
10. 15 mm Allen key (eg. Facom: ET5)
11. 16 mm Allen key (ego Facom: ET6)
12. TORX T20 bit
13. TORX T30 bit
14. Puller (eg. Facom: U35)
15. Puller (eg. Facom: U32/350)

Screw tightening torque

Identification	Screw Ø	Torque N•m
Field term. block screw	M4	4
Field screw	M6	10
Diode bridge screw	M6	5
Diode nut	M5	4
Assembly rod	M8	20
Earthing screw	M6	5
Balancing bolt	M5	4
Disc/shaft screw	M10	66
Lifting screw	M8	4
Louvre screw	M6	5
Cover screw	M6	5

Accessing connections and the regulation system

The terminals are accessed by removing the terminal box lid.

To access the adjustment potentiometers on the AVR, the side plate should be removed.

Accessing, checking and replacing diodes

Dismantling

- Remove the terminal box lid].
- Remove the air intake louvre.
- Unscrew the fixing clamps on the power output cables, disconnect E+. E- on the exciter and R 791 module.
- Remove the 4 nuts on the tie rods.
- Remove the NDE bracket using an extractor: eg. U.32 -350 (FACOM).
- Remove the surge suppressor.
- Remove the 4 fixing screws from the diode bridges on the armature.
- Disconnect the diodes.
- Check the 6 diodes using either an ohmmeter or a battery lamp.

Reassembly

- Replace the diodes, respecting the polarity.
- Replace the surge suppressor.
- Insert a new O ring in the bearing housing.
- Refit the NDE bracket (see fig 24) and pass the bundle of wires between the top bars of the flange.
- Replace the fixing clamps on the cables and the R791 module.
- Refit the air intake louvre.
- Replace the terminal box lid.

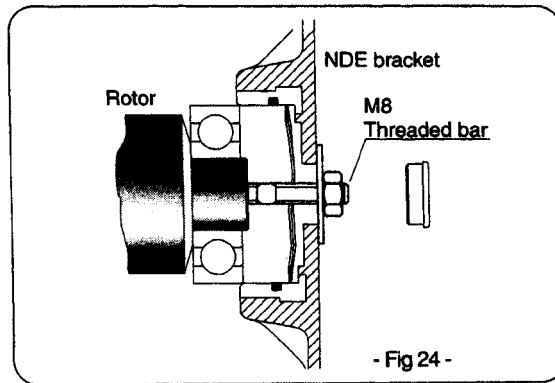

Replacing the NDE bearing on a single-bearing machine

Dismantling

Dismantle the NDE bracket and remove the bearing using a puller. (See Fig 25).

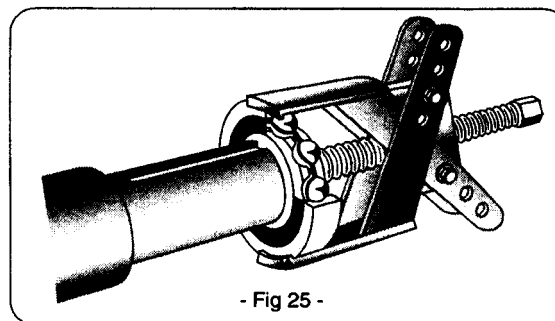

Reassembly

- Heat the inner slipring of a new bearing by induction or in a drying oven at 80 °C (do not use an oil bath) and fit it to the machine.
- Place the preloading wavy washer in the flange and fit a new O ring seal.
- Replace the NDE bracket.
- Rest the rotor on one of its poles, then slide it out. Use the tube as a lever arm to assist dismantling.

-After extraction, be careful with the fan. It is necessary to replace the fan in case of disassembling.

NOTE: If intervention is required on the main field (rewinding, replacement of components), the rotor assembly must be rebalanced.

Reassembly

-Follow the dismantling procedure in reverse order. Take care not to knock the windings when refitting the rotor in the stator.

-If you replace the fan, respect the assembly guide (fig 27). Use a tube and a screw.

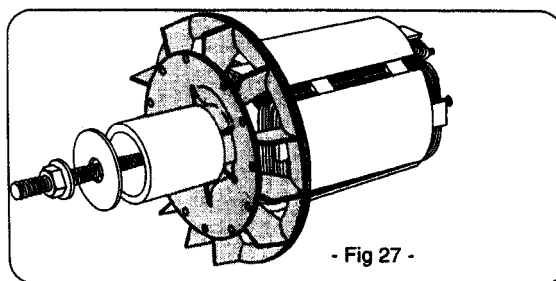

Follow the procedure for reassembling the bearings.



After final adjustments, the access panels or cover should be refitted.

Electrical characteristics table

Alternator - 2/4 - pole - 50/60 Hz - No. 6 standard winding. (400V for the excitation values).

The voltage and current values are given for no-load operation and operation at rated load with separate field excitation. All values are given at ± 10% (for exact values, consult the test report) and are subject to change without prior warning.

Alternator 4 pole with AREP excitation Resistances at 20°C () -50/60 Hz

Type 42.2	VS2*	S4	S5	M6	M7	L9
L/N stator	0,76	0,34	0,34	0,22	0,22	0,2
Rotor	2,1	2,7	2,7	3,3	3,3	3,7
Auxil.wind. X1, X2	0,5	0,3	0,3	0,26	0,26	0,23
Auxil.wind Z1,Z2	0,6	0,5	0,5	0,44	0,44	0,41
Field	6	6	6	6	6	6
Armature	0,5	0,51	0,51	0,51	0,51	0,51

Alternator 4 pole with AREP excitation

Field excitation current (i exc (A) -400V -50Hz)

Symbols: “i exc”. excitation current of the exciter field.

Type 42.2	VS2*	S4	S5	M6	M7	L9
No-load	0,9	0,9	0,9	0,8	0,8	0,7
At rated load	2,4	2,1	2,3	2	2,3	2,3

(*) Lister type machine

For 60Hz machines the “i exc” values are approximately 5 to 10% less.

Resistances at 20 °C (Ω)

LSA 43.2	Stator L/N	Rotor	Wind. X1,X2	Widng. Z1,Z2	Field	Armat.
S1	0,155	1,35	0,32	0,52	4,6	0,23
S15	0,155	1,35	0,32	0,52	4,6	0,23
S25	0,155	1,35	0,32	0,52	4,6	0,23
S35	0,128	1,41	0,29	0,5	4,6	0,23
M45	0,105	1,57	0,26	0,51	4,6	0,23
L65	0,083	1,76	0,26	0,44	4,6	0,23
L8	0,063	1,96	0,21	0,4	4,6	0,23

Field excitation current i exc (A) -400 V -50 Hz

"i exc": excitation current of the exciter field

LSA 43.2	no load	on load
S1	1	2,6
S15	1	3
S25	1	3,2
S35	1	3,6
M45	0,8	3,2
L65	0,8	3,2
L8	0,8	3,2

Resistances at 20 °C (Ω)

LSA 44.2	Stator L/N	Rotor	Wind. X1,X2	Wind. Z1,Z2	Field	Armat.
VS3	0,046	2,51	0,3	0,5	4,9	0,5
VS45	0,046	2,51	0,3	0,5	4,9	0,5
S7	0,036	2,91	0,21	0,32	4,9	0,5
S75	0,036	2,91	0,21	0,32	4,9	0,5
M95	0,024	3,32	0,17	0,28	4,9	0,5
L12	0,019	3,66	0,16	0,21	4,9	0,5

Field excitation current i exc (A) -400 V -50 Hz

"i exc": excitation current of the exciter field

LSA 44.2	no load	on load
VS3	1	3,6
VS45	1	4,2
S7	1	3,8
S75	1	4,2
M95	1,2	4
L12	1	3,8

EXPLODED VIEWS

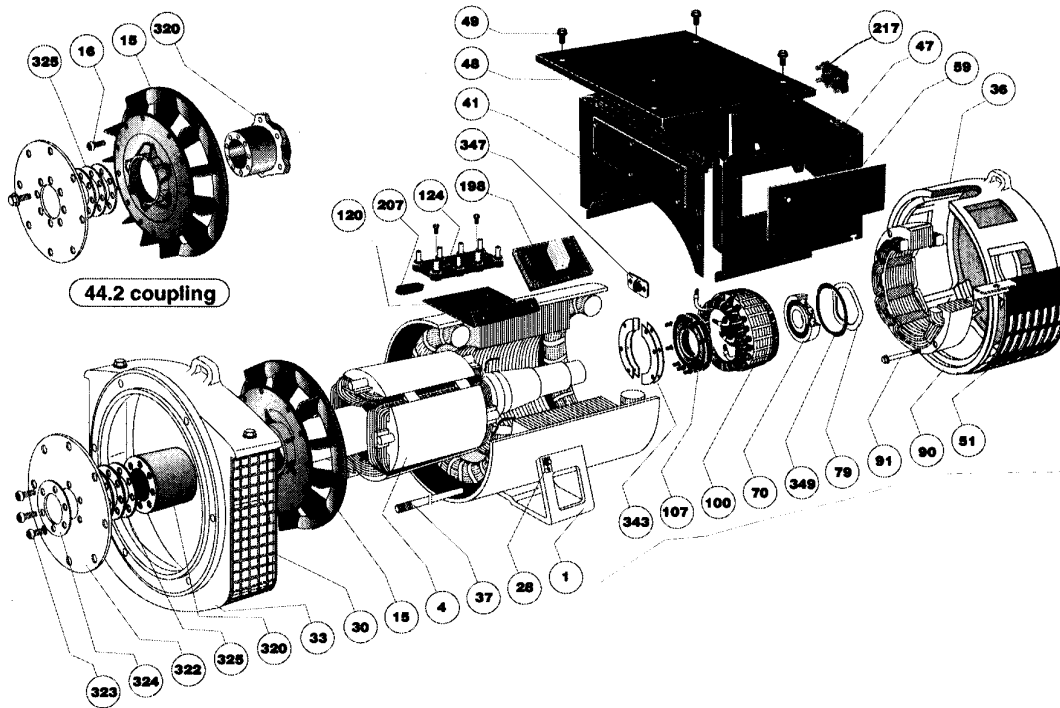

No.	Nbr	Desc	No.	Nbr	Desc
1	1	Stator assy	59	3	Inspection door
4	1	Rotor assy	120	1	Terminal block suprt
15	1	Fan	124	1	Terminal block
16	6	Fixing screws	198	1	Voltage regulator
28	1	Earth terminal	207	1	AVR damper seal
30	1	DE shield	217	1	Terminal block
33	1	Air outlet grille	290	1	PMG hsg
36	1	Shield on exciter end	291	1	Adaption shaft
37	4	Tie rod	292	1	Magnetic rotor
41	1	Cover front panel	293	1	Stator
47	1	Cover rear panel	294	1	Fixing screws
48	1	Cover top panel	295	1	Tie rod
49	34	Fixing screws	296	1	Cable gland washer/nut
297	1	End Plate			
320	1	Hub			
322	1	Coupling disc			
323	-	Fixing screws			
324	1	Clamping washer			
325	-	Spacer shim			
347	1	Surge suppressor			



Portable Power

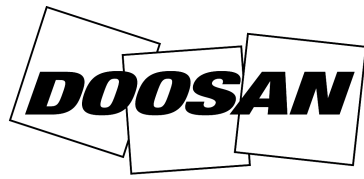

Portable Power