

KOMATSU

PC210-11 **PC210LC-11** **PC210NLC-11**

EU Stage IV Engine

HYDRAULIC EXCAVATOR



PC210

ENGINE POWER

123 kW / 165 HP @ 2.000 rpm

OPERATING WEIGHT

PC210-11: 22.120 - 23.460 kg
PC210LC-11: 22.450 - 24.110 kg
PC210NLC-11: 22.400 - 23.830 kg

BUCKET CAPACITY

max. 1,69 m³

Walk-Around

PC210/LG/NLG-11



ENGINE POWER

123 kW / 165 HP @ 2.000 rpm

OPERATING WEIGHT

PC210-11: 22.120 - 23.460 kg
PC210LC-11: 22.450 - 24.110 kg
PC210NLC-11: 22.400 - 23.830 kg

BUCKET CAPACITY

max. 1,69 m³



EXCEPTIONAL WORKABILITY AND ENVIRONMENTAL PERFORMANCE

Powerful and Environmentally Friendly

- EU Stage IV engine
- Adjustable idle shutdown
- Komatsu fuel-saving technology

First-Class Comfort

- Fully air-suspended operator station
- Low-noise design
- Widescreen monitor

Maximised Efficiency

- Increased productivity
- Built-in versatility and superior productivity
- Enhanced engine management
- Improved hydraulic efficiency

Safety First

- Komatsu SpaceCab™
- KomVision surround view system
- Neutral position detection system

Quality You Can Rely On

- Komatsu-quality components
- Extensive dealer support network

KOMTRAX

- Komatsu Wireless Monitoring System
- 3G mobile communications
- Integrated communication antenna
- Increased operational data and reports



A maintenance program
for Komatsu customers

Powerful and Environmentally Friendly



Higher productivity

The PC210-11 is quick and precise. It features a powerful Komatsu EU Stage IV engine, Komatsu's Closed Center Load Sensing (CLSS) hydraulic system and first-class Komatsu comfort to provide a fast response and unrivalled productivity for its class.

Komatsu fuel-saving technology

Fuel consumption on the PC210-11 is lower by up to 6%. Engine management is enhanced. The variable speed matching of the engine and hydraulic pump and a viscous fan clutch guarantee efficiency and precision during single and combined movements.

Adjustable idle shutdown

The Komatsu auto idle shutdown automatically turns off the engine after it idles for a set period of time. This feature can easily be programmed from 5 to 60 minutes, to reduce unnecessary fuel consumption and exhaust emissions, and to lower operating costs. An Eco-gauge and the Eco guidance tips on the cab monitor further encourage efficient operations.

PC210/LG/NLG-11

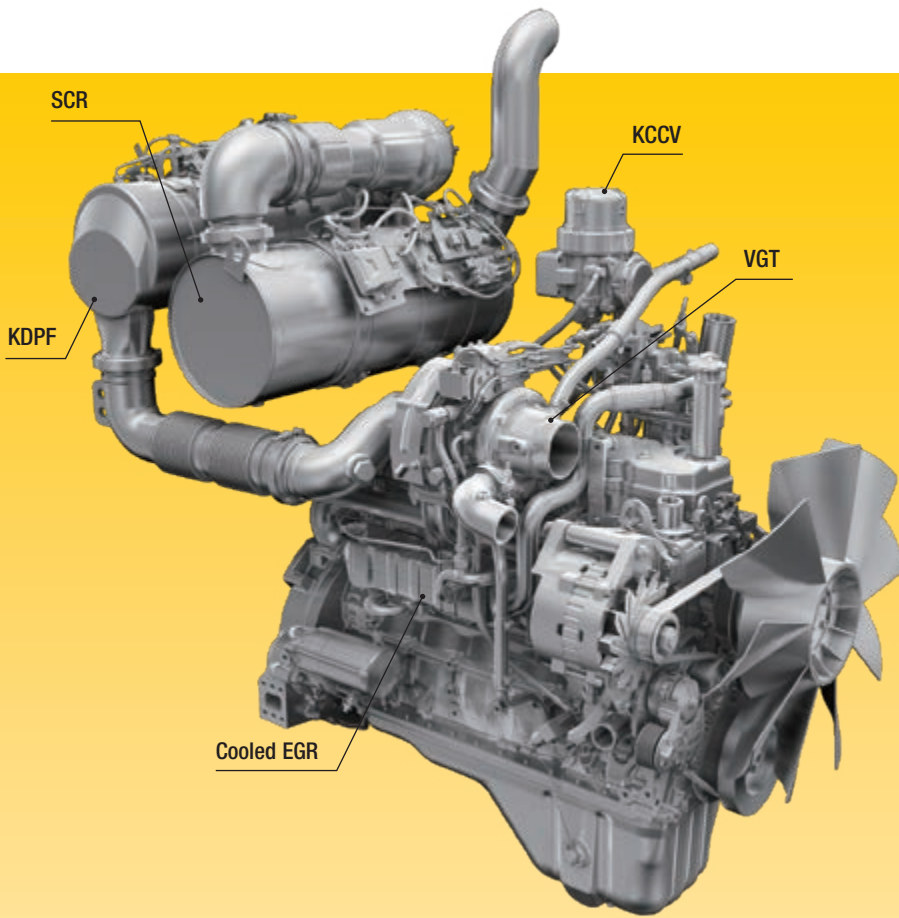

Komatsu EU Stage IV

The Komatsu EU Stage IV engine is productive, dependable and efficient. With ultra-low emissions, it provides a lower environmental impact and a superior performance to help reduce operating costs and lets the operator work in complete peace of mind.

Heavy-duty aftertreatment

The aftertreatment system combines a Komatsu Diesel Particulate Filter (KDPF) and Selective Catalytic Reduction (SCR). The SCR injects the correct amount of AdBlue® into the system at the proper rate to break down NOx into water (H₂O) and non-toxic nitrogen gas (N₂). NOx emissions are reduced by 80% vs. EU Stage IIIB engines.

Exhaust Gas Recirculation (EGR)

Cooled EGR is a technology well-proven in current Komatsu engines. The increased capacity of the EGR cooler now ensures very low NOx emissions and a better engine performance.

Komatsu Closed Crankcase Ventilation (KCCV)

Crankcase emissions (blow-by gas) are passed through a CCV filter. The oil mist trapped in the filter is returned back to the crankcase while the filtered gas is returned to the air intake.

High-Pressure Common Rail (HPCR)

To achieve complete fuel burn and lower exhaust emissions, the heavy-duty High-Pressure Common Rail fuel injection system is computer controlled to deliver a precise quantity of pressurised fuel into the redesigned engine combustion chamber by multiple injections.

Variable Geometry Turbo (VGT)

The VGT provides optimal airflow to the engine combustion chamber under all speed and load conditions. Exhaust gas is cleaner, fuel economy is improved while machine power and performance are maintained.

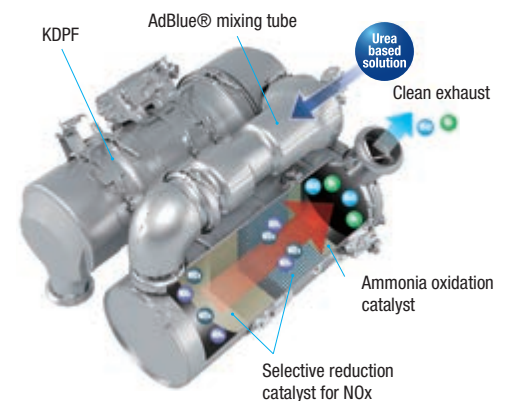

Eco-gauge, Eco guidance and fuel consumption gauge

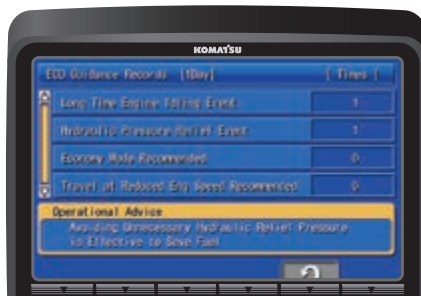

ECO guidance record

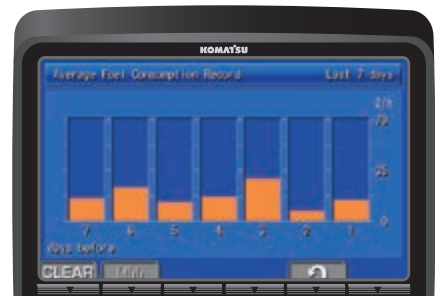

Fuel consumption history

Maximised Efficiency

Built-in versatility

Powerful and precise, the Komatsu PC210-11 is equipped to efficiently carry out any task your business requires. On all jobsites, big or small, for digging, trenching, landscaping or site preparation, the Komatsu hydraulic system always provides maximum productivity and control.



Two-piece boom

A wide choice of options

Two optional attachment lines are available and ten attachment memory settings are simply customised. Combined with a standard-fit hydraulic quick coupler power circuit, it's easier than ever to switch working styles. With a choice of arms and undercarriages, you can configure the PC210-11 to match specific demands for transport, working envelope or duty.



Two optional hydraulic lines to mount a variety of attachments

6 working modes

The PC210-11 delivers the power required with the lowest fuel usage. 6 working modes are available: Power, Lifting/Fine Operation, Breaker, Economy, Attachment Power and Attachment Economy. The operator can ideally balance the Economy mode between power and economy to match the work at hand. The oil flow delivered to hydraulic attachments is also adjustable directly on the class-leading widescreen monitor panel.



Full length track roller guards (optional)



Versatility at your fingertips: select the perfect setting for each job





First-Class Comfort

Increased comfort

In the wide Komatsu SpaceCab™, a standard air-suspended high-back seat, heated for improved comfort and with fully adjustable armrests, is the centre of a comfortable and low-fatigue working environment. High visibility and ergonomic controls further assist to maximise the operator's productivity.

Perfect operator convenience

In addition to the standard radio, the PC210-11 has an auxiliary input for connecting external devices and play music through the cab speakers. Two 12-volt power ports are also incorporated in the cab. Proportional controls are fitted as standard for safe and precise operation of attachments.

Low-noise design

Komatsu crawler excavators have very low external noise levels and are especially well-suited for work in confined spaces or urban areas. The optimal usage of sound insulation and of sound absorbing materials helps to make noise levels inside the cab comparable to those of an executive car.



Convenient, ergonomic and precise control: joysticks with proportional control button for attachments



Plenty of storage room, a hot and cool box, a magazine box and a cup holder



Armrest with simple height adjustment

Information & Communication Technology

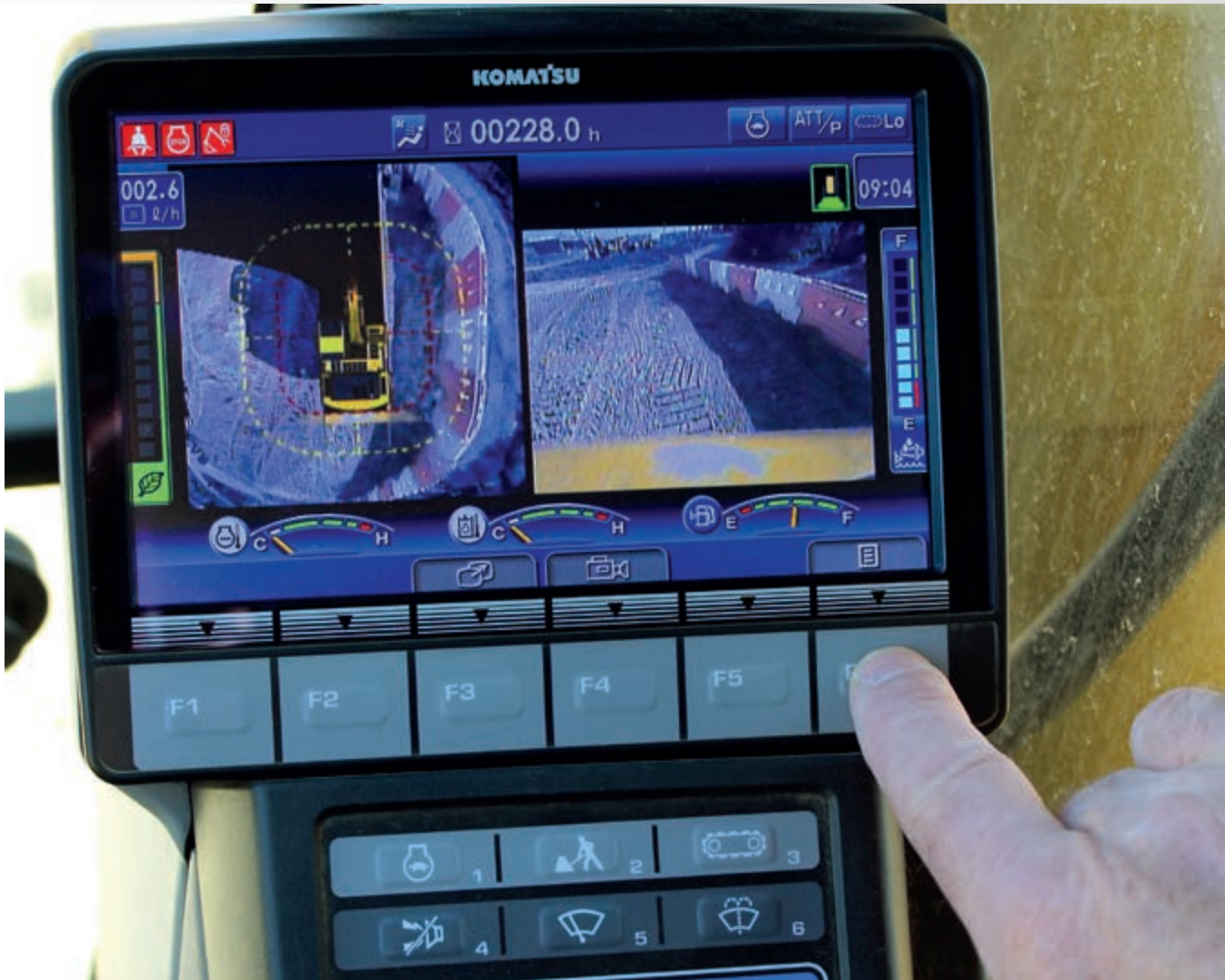

Lower operating costs

Komatsu ICT contributes to the reduction of operating costs by assisting to comfortably and efficiently manage operations. It raises the level of customer satisfaction and the competitive edge of our products.

Widescreen monitor

Conveniently customisable and with a choice of 26 languages, the wide-screen monitor with simple switches and multifunction keys gives fingertip access to a large range of functions and operating info. The rear camera view and an AdBlue® level gauge are now incorporated into the default main screen.

An evolutionary interface

Helpful information is now easier than ever to find and understand with the upgraded monitor interface. An optimal main screen for the ongoing work can be selected simply by pressing the F3 key.



Quick view on the operation logs



With KomVision, various camera view options are available whilst maintaining constant "birdview" from above the machine

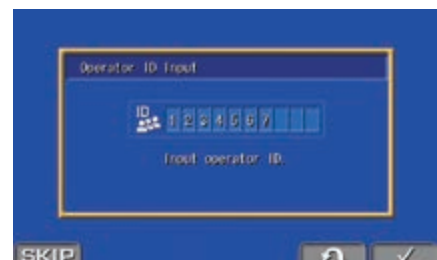

Operator identification function

Safety First

PC210/LG/NLG-11



Optimal jobsite safety

Safety features on the Komatsu PC210-11 comply with the latest industry standards and work in synergy to minimise risks to people in and around the machine. A neutral detection system for travel and work equipment levers increase jobsite safety, along with a seat belt caution indicator and an audible travel alarm. Highly durable anti-slip plates – with additional high friction covering – maintain long term traction performance.



KomVision cameras

KomVision

KomVision machine visibility gives the operator a constant clear view of the safety zone around the machine. This allows the operator to focus on the work at hand even in low light conditions.



Exceptional operator protection

Komatsu SpaceCab™

The ROPS cab has a tubular steel frame and provides high shock absorbency, impact resistance and durability. The seat belt is well designed to keep the operator in the safety zone of the cab in the event of a rollover. Optionally the cab can be fitted with a Falling Object Protective System (FOPS) with openable front guard.



Hand rails and anti-slip plates

Safe maintenance

Thermal guards around high temperature areas of the engine, protected fan belt and pulleys, a pump/engine partition that prevents hydraulic oil from spraying onto the engine, and exceptionally sturdy handrails: in Komatsu tradition, the highest safety level is provided for a fast and smooth maintenance.

Quality You Can Rely On

Komatsu-quality

With the latest computer techniques and a thorough test programme, Komatsu produces equipment to meet your highest standards. All major components of the PC210-11 are designed and directly manufactured by Komatsu, and essential machine functions are perfectly matched for a highly reliable and productive excavator.

Rugged design

Maximum toughness and durability are the cornerstones of Komatsu's philosophy – along with safety and top class customer service. Single piece plates and castings are used in key areas of the machine's structure for good load distribution. Highly durable rubbing strips on the underside of the arm protect the structure against impact damage.

Extensive support network

The extensive Komatsu distribution and dealer network is standing by to help keep your fleet in optimum condition. Customised servicing packages are available, with express availability of spare parts, to make sure that your Komatsu equipment continues to perform at its peak.



Durable and reliable undercarriage design for maximum protection



Cast boom foot and single piece boom plates

Easy Maintenance



Central service points

Komatsu designed the PC210-11 with centralised and conveniently located service points to make necessary inspections and maintenance quick and easy.

Komatsu CARE™

Komatsu CARE™ is a maintenance program that comes as standard with your new Komatsu machine. It covers factory-scheduled maintenance, performed with Komatsu Genuine parts by Komatsu-trained technicians. Depending on your machine's engine, it also offers extended coverage of the Komatsu Diesel Particulate Filter (KDPF) or the Komatsu Diesel Oxidation Catalyst (KDOC), and of the Selective Catalytic Reduction (SCR). Please contact your local Komatsu distributor for terms and conditions.



Long-life oil filters

The Komatsu Genuine hydraulic oil filter uses high-performance filtering material for long replacement intervals, which significantly reduces maintenance costs.



AdBlue® tank

For simple access, the AdBlue® tank is installed on the front stairway.

Flexible warranty

When you purchase Komatsu equipment, you gain access to a broad range of programmes and services that have been designed to help you get the most from your investment. For example, Komatsu's Flexible Warranty Programme provides a range of extended warranty options on the machine and its components. These can be chosen to meet your individual needs and activities. This programme is designed to help reduce total operating costs.

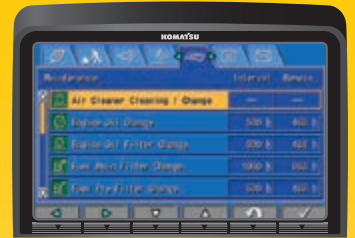

Basic maintenance screen

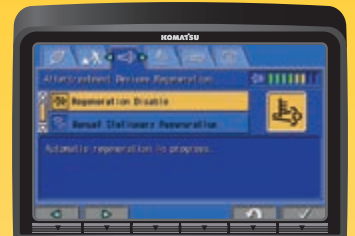

Aftertreatment device regeneration screen for the KDPF



AdBlue® level and refill guidance



KOMTRAX

The way to higher productivity

KOMTRAX uses the latest wireless monitoring technology. Compatible on PC, smartphone or tablet, it delivers insightful and cost saving information about your fleet and equipment, and offers a wealth of information to facilitate peak machine performance. By creating a tightly integrated web of support it allows proactive and preventive maintenance and helps to efficiently run a business.



Knowledge

You get quick answers to basic and critical questions about your machines – what they're doing, when they did it, where they're located, how they can be used more efficiently and when they need to be serviced. Performance data is relayed by wireless communication technology (Satellite, GPRS or 3G depending on model) from the machine to a computer and to the local Komatsu distributor – who's readily available for expert analysis and feedback.

Power

The detailed information that KOMTRAX puts at your fingertips 24 hours a day, 7 days a week gives the power to make better daily and long-term strategic decisions – at no extra cost. Problems can be anticipated, maintenance schedules customised, downtime minimised and machines kept where they belong: working on the jobsite.

Convenience

KOMTRAX enables convenient fleet management on the web, wherever you are. Data is analysed and packaged specifically for effortless and intuitive viewing in maps, lists, graphs and charts. You can foresee eventual maintenance issues and required spare parts, and troubleshoot a problem before Komatsu technicians arrive on site.



Specifications

ENGINE

Model	Komatsu SAA6D107E-3
Type	Common rail direct injection, water-cooled, emissionised, turbocharged, after-cooled diesel
Engine power	
at rated engine speed	2.000 rpm
ISO 14396	123 kW/165 HP
ISO 9249 (net engine power)	123 kW/165 HP
No. of cylinders	6
Bore × stroke	107 × 124 mm
Displacement	6,69 l
Air filter type	Double element type with monitor panel dust indicator and auto dust evacuator
Cooling	Suction type cooling fan with radiator fly screen
Fuel	Diesel fuel, conforming to EN590 Class 2/Grade D. Paraffinic fuel capability (HVO, GTL, BTL), conforming to EN 15940:2016

HYDRAULIC SYSTEM

Type	HydrauMind. Closed-centre system with load sensing and pressure compensation valves
Additional circuits	2 additional circuits with proportional control can be installed
Main pump	2 variable displacement piston pumps supplying boom, arm, bucket, swing and travel circuits
Maximum pump flow	475 l/min
Relief valve settings	
Implement	380 kg/cm ²
Travel	380 kg/cm ²
Swing	295 kg/cm ²
Pilot circuit	33 kg/cm ²

SERVICE REFILL CAPACITIES

Fuel tank	400 l (PC210NLC: 325 l)
Radiator	30,7 l
Engine oil	23,1 l
Swing drive	6,5 l
Hydraulic tank	132 l
Final drive (each side)	5,0 l
AdBlue® tank	23,1 l (PC210NLC: 18,8 l)

OPERATING WEIGHT (APPR.)

	MONO BOOM						TWO-PIECE BOOM					
	PC210-11		PC210LC-11		PC210NLC-11		PC210-11		PC210LC-11		PC210NLC-11	
Triple grouser shoes	Operating weight	Ground pressure	Operating weight	Ground pressure	Operating weight	Ground pressure	Operating weight	Ground pressure	Operating weight	Ground pressure	Operating weight	Ground pressure
500 mm	–	–	–	–	22.400 kg	0,57 kg/cm ²					23.200 kg	0,59 kg/cm ²
600 mm	22.120 kg	0,51 kg/cm ²	22.450 kg	0,48 kg/cm ²	22.760 kg	0,48 kg/cm ²	22.920 kg	0,53 kg/cm ²	23.250 kg	0,49 kg/cm ²	23.560 kg	0,50 kg/cm ²
700 mm	22.370 kg	0,45 kg/cm ²	22.720 kg	0,41 kg/cm ²	23.030 kg	0,42 kg/cm ²	23.170 kg	0,46 kg/cm ²	23.520 kg	0,42 kg/cm ²	23.830 kg	0,43 kg/cm ²
800 mm	22.660 kg	0,40 kg/cm ²	23.040 kg	0,37 kg/cm ²	–	–	23.460 kg	0,41 kg/cm ²	23.840 kg	0,38 kg/cm ²		
900 mm	–	–	23.310 kg	0,33 kg/cm ²	–	–			24.110 kg	0,34 kg/cm ²		

Operating weight, including specified work equipment, 2,9 m arm, 650 kg bucket, operator, lubricant, coolant, full fuel tank and the standard equipment.

SWING SYSTEM

Type	Axial piston motor driving through planetary double reduction gearbox
Swing lock	Electrically actuated wet multidisc brake integrated into swing motor
Swing speed	0 - 12,4 rpm
Swing torque	65 kNm

DRIVES AND BRAKES

Steering control	2 levers with pedals giving full independent control of each track
Drive method	Hydrostatic
Travel operation	Automatic 3-speed selection
Gradeability	70%, 35°
Max. travel speeds	
Lo / Mi / Hi	3,0 / 4,1 / 5,5 km/h
Maximum drawbar pull	20.600 kg
Brake system	Hydraulically operated discs in each travel motor

UNDERCARRIAGE

Construction	X-frame centre section with box section track frames
Track assembly	
Type	Fully sealed
Shoes (each side)	45 (PC210), 49 (PC210LC/NLC)
Tension	Combined spring and hydraulic unit
Rollers	
Track rollers (each side)	7 (PC210), 9 (PC210LC/NLC)
Carrier rollers (each side)	2

ENVIRONMENT

Engine emissions	Fully complies with EU Stage IV exhaust emission regulations
Noise levels	
LwA external	100 dB(A) (2000/14/EC Stage II)
LpA operator ear	67 dB(A) (ISO 6396 dynamic test)
Vibration levels (EN 12096:1997)	
Hand/arm	≤ 2,5 m/s ² (uncertainty K = 0,49 m/s ²)
Body	≤ 0,5 m/s ² (uncertainty K = 0,24 m/s ²)
Contains fluorinated greenhouse gas HFC-134a (GWP 1430). Quantity of gas 0,9 kg, CO ₂ equivalent 1,29 t	

Dimensions & Performance Figures

MACHINE DIMENSIONS	PC210-11	PC210LC-11	PC210NLC-11
A Overall width of upper structure	2.705 mm	2.705 mm	2.540 mm
B Overall height of cab	3.045 mm	3.045 mm	3.065 mm
C Overall length of basic machine	5.025 mm	5.215 mm	5.085 mm
D Tail length	2.990 mm	2.990 mm	2.860 mm
Tail swing radius	3.020 mm	3.020 mm	2.880 mm
E Clearance under counterweight	1.085 mm	1.085 mm	1.105 mm
F Machine tail height	2.250 mm	2.250 mm	2.270 mm
F' Machine tail height (top of engine cover)	2.765 mm	2.765 mm	2.785 mm
G Ground clearance	440 mm	440 mm	440 mm
H Tumbler centre distance	3.275 mm	3.655 mm	3.655 mm
I Track length	4.070 mm	4.450 mm	4.450 mm
J Track gauge	2.200 mm	2.380 mm	2.040 mm
K Track shoe width	600, 700, 800 mm	600, 700, 800, 900 mm	500, 600, 700 mm
L Overall track width with 500 mm shoes	-	-	2.540 mm
Overall track width with 600 mm shoes	2.800 mm	2.980 mm	2.640 mm
Overall track width with 700 mm shoes	2.900 mm	3.080 mm	2.740 mm
Overall track width with 800 mm shoes	3.000 mm	3.180 mm	-
Overall track width with 900 mm shoes	-	3.280 mm	-

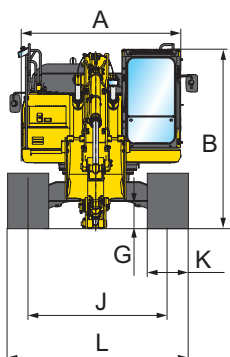

MONO BOOM

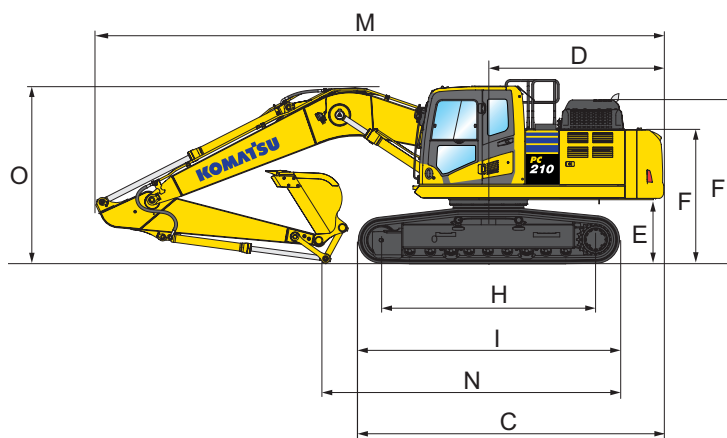

TWO-PIECE BOOM

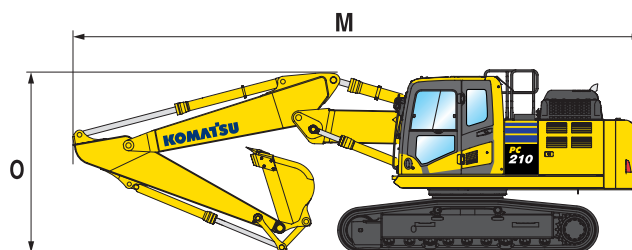

TRANSPORT DIMENSIONS	MONO BOOM		TWO-PIECE BOOM	
Arm length	2,4 m	2,9 m	2,4 m	2,9 m
M Transport length PC210/LC	9.775 mm	9.705 mm	9.570 mm	9.715 mm
Transport length PC210NLC	9.645 mm	9.705 mm	9.510 mm	9.615 mm
N Length on ground (transport) PC210	5.695 mm	4.810 mm	5.970 mm	5.185 mm
Length on ground (transport) PC210LC	5.695 mm	4.810 mm	6.160 mm	5.375 mm
Length on ground (transport) PC210NLC	5.800 mm	5.000 mm	6.265 mm	5.465 mm
O Overall height (to top of boom) PC210/LC	3.280 mm	3.135 mm	3.135 mm	3.165 mm
Overall height (to top of boom) PC210NLC	3.190 mm	3.155 mm	3.155 mm	3.185 mm

Dimensions & Performance Figures

PC210-11 / MAX. BUCKET CAPACITY AND WEIGHT

	MONO BOOM		TWO-PIECE BOOM	
	2,4 m	2,9 m	2,4 m	2,9 m
Arm length	2,4 m	2,9 m	2,4 m	2,9 m
Material weight up to 1,2 t/m ³	1,59 m ³ 1.125 kg	1,44 m ³ 1.050 kg	1,30 m ³ 975 kg	1,18 m ³ 925 kg
Material weight up to 1,5 t/m ³	1,35 m ³ 1.000 kg	1,23 m ³ 950 kg	1,10 m ³ 875 kg	1,00 m ³ 825 kg
Material weight up to 1,8 t/m ³	1,10 m ³ 925 kg	1,07 m ³ 850 kg	0,96 m ³ 800 kg	0,87 m ³ 750 kg

PC210LC-11 / MAX. BUCKET CAPACITY AND WEIGHT

	MONO BOOM		TWO-PIECE BOOM	
	2,4 m	2,9 m	2,4 m	2,9 m
Arm length	2,4 m	2,9 m	2,4 m	2,9 m
Material weight up to 1,2 t/m ³	1,68 m ³ 1.200 kg	1,65 m ³ 1.150 kg	1,50 m ³ 1.075 kg	1,38 m ³ 1.025 kg
Material weight up to 1,5 t/m ³	1,53 m ³ 1.100 kg	1,40 m ³ 1.025 kg	1,28 m ³ 975 kg	1,18 m ³ 925 kg
Material weight up to 1,8 t/m ³	1,30 m ³ 1.000 kg	1,22 m ³ 925 kg	1,11 m ³ 875 kg	1,02 m ³ 850 kg

PC210NLC-11 / MAX. BUCKET CAPACITY AND WEIGHT

	MONO BOOM		TWO-PIECE BOOM	
	2,4 m	2,9 m	2,4 m	2,9 m
Arm length	2,4 m	2,9 m	2,4 m	2,9 m
Material weight up to 1,2 t/m ³	1,38 m ³ 1.025 kg	1,24 m ³ 950 kg	1,27 m ³ 950 kg	1,15 m ³ 900 kg
Material weight up to 1,5 t/m ³	1,18 m ³ 925 kg	1,05 m ³ 850 kg	1,08 m ³ 875 kg	0,98 m ³ 825 kg
Material weight up to 1,8 t/m ³	1,00 m ³ 850 kg	0,91 m ³ 775 kg	0,94 m ³ 800 kg	0,85 m ³ 750 kg

Max. capacity and weight have been calculated according to ISO 10567:2007.

Please consult with your distributor for the correct selection of buckets and attachments to suit the application.

BUCKET AND ARM FORCE

	2,4 m	2,9 m
Arm length	2,4 m	2,9 m
Bucket digging force	16.500 kg	14.100 kg
Bucket digging force at PowerMax	17.500 kg	15.200 kg
Arm crowd force	12.200 kg	10.300 kg
Arm crowd force at PowerMax	13.000 kg	11.000 kg



Working Range

MONO BOOM

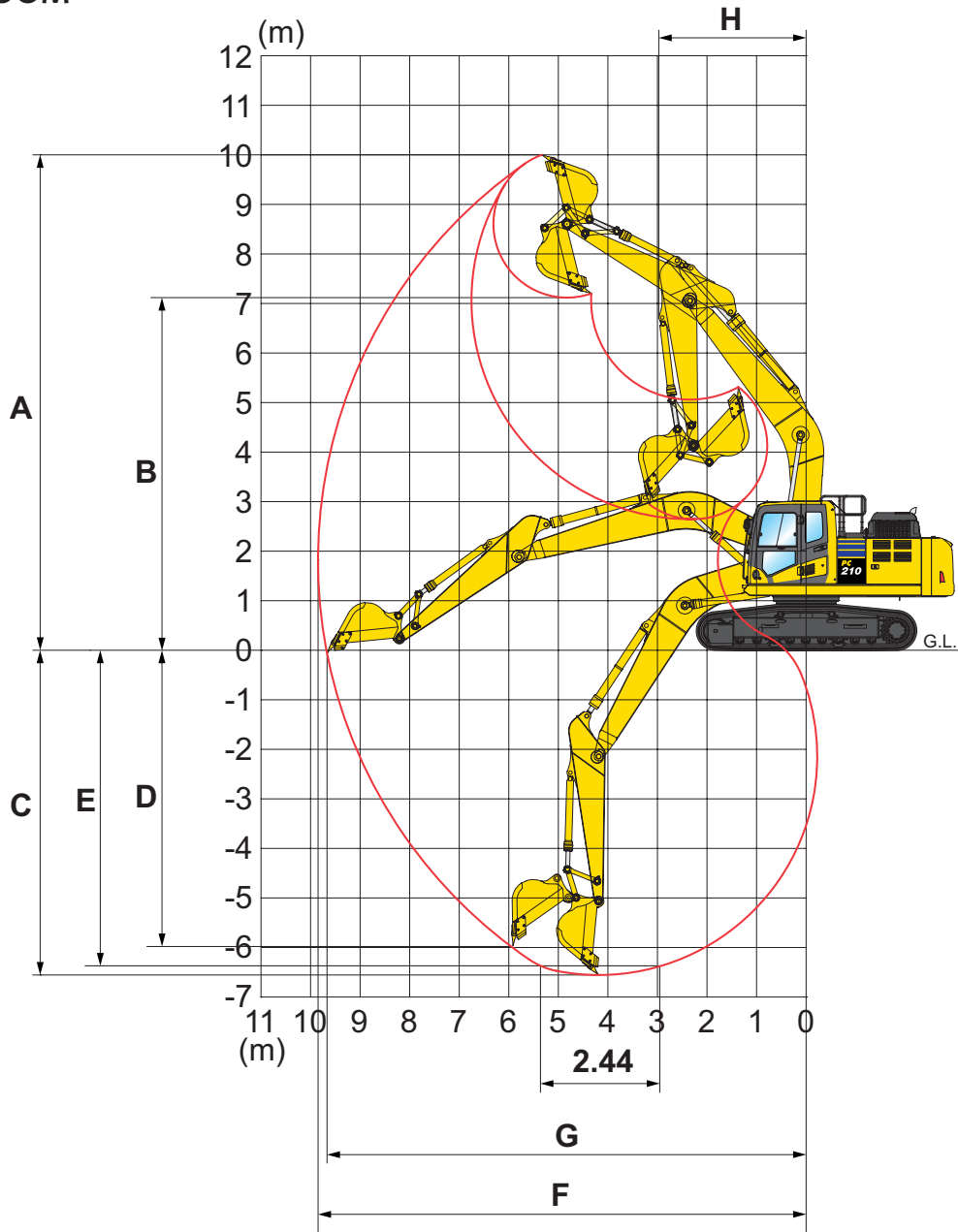

WORKING RANGE

PC210/LC-11

PC210NLC-11

	2,4 m	2,9 m	2,4 m	2,9 m
Arm length	2,4 m	2,9 m	2,4 m	2,9 m
A Max. digging height	9.800 mm	10.000 mm	9.740 mm	10.070 mm
B Max. dumping height	6.890 mm	7.110 mm	6.870 mm	7.190 mm
C Max. digging depth	6.095 mm	6.620 mm	5.980 mm	6.490 mm
D Max. vertical wall digging depth	5.430 mm	5.980 mm	5.390 mm	5.910 mm
E Max. digging depth of cut for 2,44 m level	5.780 mm	6.370 mm	5.755 mm	6.305 mm
F Max. digging reach	9.380 mm	9.875 mm	9.355 mm	9.850 mm
G Max. digging reach at ground level	9.190 mm	9.700 mm	9.160 mm	9.655 mm
H Min. swing radius	3.090 mm	3.040 mm	3.065 mm	2.975 mm
I Max. height at min. swing radius	8.080 mm	8.005 mm	8.130 mm	8.085 mm

TWO-PIECE BOOM

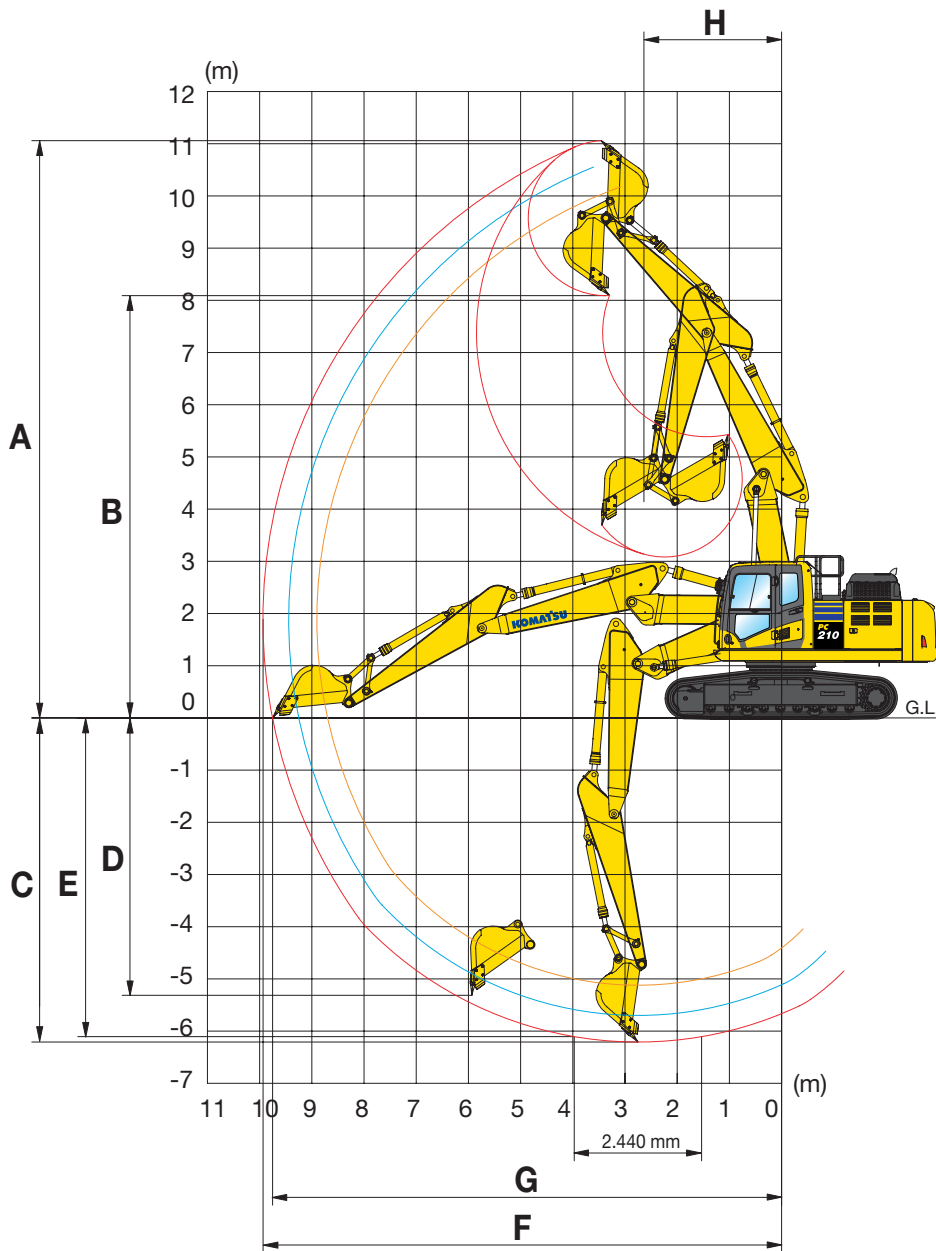

WORKING RANGE	PC210/LC-11		PC210NLC-11	
	2,4 m	2,9 m	2,4 m	2,9 m
Arm length	2,4 m	2,9 m	2,4 m	2,9 m
A Max. digging height	10.590 mm	11.060 mm	10.605 mm	11.060 mm
B Max. dumping height	7.625 mm	8.090 mm	7.640 mm	8.090 mm
C Max. digging depth	5.710 mm	6.210 mm	5.695 mm	6.210 mm
D Max. vertical wall digging depth	4.750 mm	5.250 mm	4.735 mm	5.250 mm
E Max. digging depth of cut for 2,44 m level	5.600 mm	6.105 mm	5.600 mm	6.105 mm
F Max. digging reach	9.415 mm	9.935 mm	9.415 mm	9.935 mm
G Max. digging reach at ground level	9.720 mm	9.750 mm	9.221 mm	9.750 mm
H Min. swing radius	2.830 mm	2.640 mm	2.830 mm	2.640 mm

Lifting Capacity

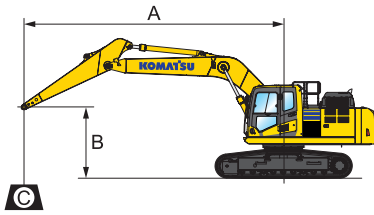

A – Reach from swing center

B – Bucket hook height

C – Lifting capacities

– Rating over front

– Rating over side

– Rating at maximum reach

Weights:

With 2,4 m arm: bucket linkage and bucket cylinder: 359 kg

With 2,9 m arm: bucket linkage and bucket cylinder: 335 kg

PC210-11 MONO BOOM

With 600 mm shoes

Arm length	A				7,5 m		6,0 m		4,5 m		3,0 m		1,5 m	
	B													
 2,4 m	7,5 m	kg	*6.100	5.960										
	6,0 m	kg	*5.700	4.350			*7.200	5.200	*7.430	*7.430				
	4,5 m	kg	5.130	3.660			7.160	5.050	*9.080	*7.700	*12.410	*12.410		
	3,0 m	kg	4.690	3.330	4.980	3.530	6.920	4.830	10.720	7.170				
	1,5 m	kg	4.550	3.210	4.880	3.440	6.680	4.620	10.220	6.740				
	0,0 m	kg	4.670	3.280	4.810	3.370	6.530	4.480	9.990	6.540				
	-1,5 m	kg	5.140	3.590			6.480	4.440	9.950	6.510	*12.410	12.170		
-3,0 m	kg	6.310	4.350			6.570	4.520	10.060	6.600	*17.480	12.380			
-4,5 m	kg													
 2,9 m	7,5 m	kg	*4.060	*4.060			*4.660	*4.660						
	6,0 m	kg	*3.820	*3.820			*6.500	5.270						
	4,5 m	kg	*3.800	3.320	5.100	3.640	*7.210	5.110	*8.140	7.840				
	3,0 m	kg	*3.930	3.040	4.990	3.530	6.960	4.860	10.510	7.290				
	1,5 m	kg	4.170	2.940	4.870	3.420	6.690	4.620	10.280	6.780				
	0,0 m	kg	4.260	2.990	4.770	3.330	6.500	4.450	6.690	6.500	*7.200	*7.200		
	-1,5 m	kg	4.620	3.220	4.740	3.300	6.420	4.370	9.860	6.420	*11.680	*11.680	*7.480	*7.480
-3,0 m	kg	5.470	3.790			6.450	4.400	9.920	6.470	*17.930	12.120	*12.100	*12.100	
-4,5 m	kg	7.780	5.280					*10.160	6.680	*15.170	12.490			

PC210LC-11 MONO BOOM

With 700 mm shoes

Arm length	A				7,5 m		6,0 m		4,5 m		3,0 m		1,5 m	
	B													
 2,4 m	7,5 m	kg	*6.100	*6.100										
	6,0 m	kg	*5.700	4.830			*7.200	5.770	7.430	7.430				
	4,5 m	kg	*5.660	4.070			*7.810	5.620	*9.080	8.610	*12.410	*12.410		
	3,0 m	kg	5.520	3.710	5.870	3.940	8.220	5.390	*11.420	8.060				
	1,5 m	kg	5.370	3.590	5.770	3.840	7.970	5.180	12.480	7.610				
	0,0 m	kg	5.530	3.670	5.700	3.780	7.810	5.040	12.230	7.410				
	-1,5 m	kg	6.100	4.020			7.760	4.990	12.190	7.380	*12.410	*12.410		
-3,0 m	kg	7.520	4.880			7.850	5.070	12.310	7.470	*17.480	14.310			
-4,5 m	kg													
 2,9 m	7,5 m	kg	*4.060	*4.060			*4.660	*4.660						
	6,0 m	kg	*3.820	*3.820			*6.500	5.840						
	4,5 m	kg	*3.800	3.700	*5.770	4.050	*7.210	5.670	*8.140	*8.140				
	3,0 m	kg	*3.930	3.400	5.890	3.940	8.260	5.430	*10.510	8.180				
	1,5 m	kg	*4.210	3.290	5.760	3.820	7.980	5.180	12.560	7.660				
	0,0 m	kg	*4.720	3.350	5.650	3.730	7.780	5.000	12.210	7.370	*7.200	*7.200		
	-1,5 m	kg	5.480	3.620	5.620	3.700	7.690	4.920	12.100	7.280	*11.680	*11.680	*7.480	*7.480
-3,0 m	kg	6.520	4.250			7.730	4.950	12.170	7.340	*17.930	14.040	*12.100	*12.100	
-4,5 m	kg	*8.800	5.940					*10.890	7.560	*15.170	14.430			

* Load is limited by hydraulic capacity rather than tipping. Ratings are based on SAE Standard No. J1097. Rated loads do not exceed 87% of hydraulic lift capacity or 75% of tipping load. Lifting capacity stated is based on lifting with bare arm. When lifting with additional equipment installed to the arm, please subtract the weight of all additional equipment from the values stated.

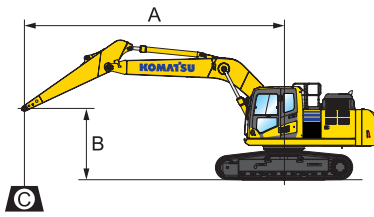

- A – Reach from swing center
- B – Bucket hook height
- C – Lifting capacities

- Rating over front
- Rating over side
- Rating at maximum reach

Weights:

With 2,4 m arm: bucket linkage and bucket cylinder: 359 kg

With 2,9 m arm: bucket linkage and bucket cylinder: 335 kg

PC210NLC-11 MONO BOOM

With 500 mm shoes

Arm length	A		⊗		7,5 m		6,0 m		4,5 m		3,0 m		1,5 m	
	B													

	7,5 m	kg	*5.950	5.550										
	6,0 m	kg	*5.600	4.000			*7.050	4.800	*7.300	*7.300				
	4,5 m	kg	*5.600	3.350			*7.700	4.650	*8.950	7.100	*12.300	*12.300		
	3,0 m	kg	5.400	3.050	5.750	3.200	8.050	4.400	*11.300	6.550				
	1,5 m	kg	5.250	2.900	5.650	3.100	7.800	4.200	12.250	6.100				
	0,0 m	kg	5.400	2.950	5.550	3.050	7.650	4.050	11.750	5.900				
	-1,5 m	kg	6.000	3.250			7.600	4.000	11.750	5.900	*12.750	10.900		
	-3,0 m	kg	7.450	4.000			7.700	4.100	12.100	6.000	*17.200	11.100		
-4,5 m	kg													

	7,5 m	kg	*4.000	*4.000			*4.650	*4.650						
	6,0 m	kg	*3.800	3.550			*6.400	4.900						
	4,5 m	kg	*3.750	3.050	*5.750	3.350	*7.100	4.750	*8.050	7.300				
	3,0 m	kg	*3.900	2.800	5.800	3.250	8.150	4.500	*10.400	6.700				
	1,5 m	kg	*4.200	2.650	5.650	3.100	7.850	4.250	12.400	6.200				
	0,0 m	kg	*4.700	2.700	5.550	3.000	7.650	4.050	11.750	5.900	*7.200	*7.200		
	-1,5 m	kg	5.400	2.950	5.500	3.000	7.550	3.950	11.750	5.800	*11.700	10.650	*7.500	*7.500
	-3,0 m	kg	6.400	3.450			7.600	4.000	12.000	5.850	*17.950	10.850	*12.100	*12.100
-4,5 m	kg	*8.650	4.850					*10.700	6.100	*14.900	11.250			

* Load is limited by hydraulic capacity rather than tipping. Ratings are based on SAE Standard No. J1097. Rated loads do not exceed 87% of hydraulic lift capacity or 75% of tipping load. Lifting capacity stated is based on lifting with bare arm. When lifting with additional equipment installed to the arm, please subtract the weight of all additional equipment from the values stated.

Lifting Capacity

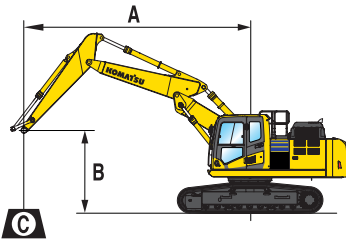

- A – Reach from swing center
- B – Bucket hook height
- C – Lifting capacities

- Rating over front
- Rating over side
- Rating at maximum reach

Weights:

With 2,4 m arm: bucket linkage and bucket cylinder: 359 kg

With 2,9 m arm: bucket linkage and bucket cylinder: 335 kg

PC210-11 TWO-PIECE BOOM

With 600 mm shoes

Arm length	A		⊕		7,5 m		6,0 m		4,5 m		3,0 m		1,5 m	
	B													
	7,5 m	kg	*5.850	*5.850					*7.800	*7.800				
	6,0 m	kg	*5.350	4.250			*6.350	5.200	*8.000	*8.000				
	4,5 m	kg	5.050	3.550			*6.700	5.050	*9.050	7.800				
	3,0 m	kg	4.600	3.250	4.900	3.450	6.900	4.800	10.700	7.150				
	1,5 m	kg	4.450	3.100	4.800	3.350	6.600	4.550	10.150	6.650				
	0,0 m	kg	4.600	3.200	4.750	3.300	6.450	4.400	9.900	6.450				
	-1,5 m	kg	5.050	3.500			6.400	4.400	9.900	6.450	*12.150	*12.150		
-3,0 m	kg													

	7,5 m	kg	*3.600	*3.600			*4.350	*4.350	*6.400	*6.400				
	6,0 m	kg	*3.300	*3.300			*5.750	5.100	*6.850	*6.850				
	4,5 m	kg	*3.200	3.050	4.850	3.350	*6.000	4.850	*8.000	7.650	*10.700	*10.700		
	3,0 m	kg	*3.250	2.750	4.700	3.200	*6.550	4.550	9.850	6.850				
	1,5 m	kg	*3.400	2.600	4.500	3.100	6.300	4.250	9.800	6.350				
	0,0 m	kg	*3.800	2.650	4.400	2.950	6.050	4.050	9.450	6.000	*7.150	*7.150		
	-1,5 m	kg	4.300	2.900	4.400	2.950	6.000	3.950	9.350	5.950	*11.700	11.400		
-3,0 m	kg													

PC210LC-11 TWO-PIECE BOOM

With 600 mm shoes

Arm length	A		⊕		7,5 m		6,0 m		4,5 m		3,0 m		1,5 m	
	B													
	7,5 m	kg	*5.850	*5.850					*7.800	*7.800				
	6,0 m	kg	*5.350	4.800			*6.350	5.850	*8.000	*8.000				
	4,5 m	kg	*5.250	4.050			*6.700	5.700	*9.050	8.800				
	3,0 m	kg	*5.300	3.650	*5.550	3.950	*7.300	5.450	*11.350	8.150				
	1,5 m	kg	5.350	3.550	5.800	3.850	8.000	5.200	12.600	7.650				
	0,0 m	kg	5.500	3.650	5.700	3.750	7.850	5.050	12.300	7.450				
	-1,5 m	kg	6.100	4.000			7.800	5.000	*11.750	7.450	*12.150	*12.150		
-3,0 m	kg													

	7,5 m	kg	*3.600	*3.600			*4.350	*4.350	*6.400	*6.400				
	6,0 m	kg	*3.300	*3.300			*5.750	5.750	*6.850	*6.850				
	4,5 m	kg	*3.200	*3.200	4.850	3.850	*6.000	5.500	*8.000	*8.000	*10.700	*10.700		
	3,0 m	kg	*3.250	2.150	*5.000	3.700	*6.550	5.150	*9.850	7.950				
	1,5 m	kg	*3.400	3.000	*5.250	3.550	*7.300	4.850	12.250	7.300				
	0,0 m	kg	*3.800	3.050	5.400	3.450	7.450	4.650	11.850	7.000	*7.150	*7.150		
	-1,5 m	kg	*4.450	3.350	5.350	3.400	7.400	4.600	11.750	6.900	*11.700	*11.700		
-3,0 m	kg													

* Load is limited by hydraulic capacity rather than tipping. Ratings are based on SAE Standard No. J1097. Rated loads do not exceed 87% of hydraulic lift capacity or 75% of tipping load. Lifting capacity stated is based on lifting with bare arm. When lifting with additional equipment installed to the arm, please subtract the weight of all additional equipment from the values stated.

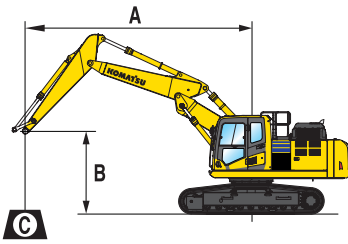

- A – Reach from swing center
- B – Bucket hook height
- C – Lifting capacities

- Rating over front
- Rating over side
- Rating at maximum reach

Weights:

With 2,4 m arm: bucket linkage and bucket cylinder: 359 kg

With 2,9 m arm: bucket linkage and bucket cylinder: 335 kg

PC210NLC-11 TWO-PIECE BOOM

With 500 mm shoes

Arm length	A			7,5 m		6,0 m		4,5 m		3,0 m		1,5 m	
	B												

	7,5 m	kg	*5.800	5.350				*7.800	7.650				
	6,0 m	kg	*5.350	3.900			*6.350	4.750	*8.000	7.550			
	4,5 m	kg	*5.250	3.250			*6.700	4.600	*9.050	7.100			
	3,0 m	kg	5.200	2.950	*5.500	3.150	*7.300	4.350	*11.400	6.500			
	1,5 m	kg	5.050	2.850	5.450	3.050	7.600	4.150	11.500	6.000			
	0,0 m	kg	5.200	2.900	5.400	3.000	7.400	4.000	11.650	5.800			
	-1,5 m	kg	5.750	3.200			7.350	3.950	11.600	5.800	*12.200	10.750	
	-3,0 m	kg											

	7,5 m	kg	*3.600	*3.600			*4.400	*4.400	*6.400	*6.400			
	6,0 m	kg	*3.300	3.300			*5.750	4.650	*6.850	*6.850			
	4,5 m	kg	*3.200	2.750	*4.850	3.050	*6.000	4.400	*8.000	6.950	*10.850	*10.850	
	3,0 m	kg	*3.250	2.450	*5.000	2.900	*6.600	4.100	*9.900	6.250			
	1,5 m	kg	*3.400	2.350	5.150	2.750	7.250	3.800	11.550	5.650			
	0,0 m	kg	*3.800	2.400	5.050	2.650	7.000	3.600	11.150	5.350	*7.150	*7.150	
	-1,5 m	kg	*4.450	2.600	5.050	2.650	6.950	3.550	11.050	5.300	*11.750	10.000	
	-3,0 m	kg											

* Load is limited by hydraulic capacity rather than tipping. Ratings are based on SAE Standard No. J1097. Rated loads do not exceed 87% of hydraulic lift capacity or 75% of tipping load. Lifting capacity stated is based on lifting with bare arm. When lifting with additional equipment installed to the arm, please subtract the weight of all additional equipment from the values stated.

Standard and Optional Equipment

ENGINE

Komatsu SAA6D107E-3 turbocharged common rail direct injection diesel engine	●
EU Stage IV compliant	●
Suction type cooling fan with radiator fly screen	●
Automatic engine warm-up system	●
Engine overheat prevention system	●
Fuel control dial	●
Auto-deceleration function	●
Adjustable idle shutdown	●
Engine key stop	●
Engine ignition can be password secured on request	●
Alternator 24 V/90 A	●
Starter motor 24 V/5,5 kW	●
Batteries 2 × 12 V/180 Ah	●

HYDRAULIC SYSTEM

Electronic closed-centre load sensing (E-CLSS) hydraulic system (HydrauMind)	●
Pump and engine mutual control (PEMC) system	●
6-working mode selection system; Power mode, Economy mode, Breaker mode, Attachment Power and Attachment Economy mode, and Lifting/Fine Operation mode	●
PowerMax function	●
PPC wrist control levers for arm, boom, bucket and swing, with sliding proportional control for attachments and 3 auxiliary buttons	●
Prepared for hydraulic quick-coupler	●
Additional hydraulic functions	○

DRIVES AND BRAKES

Hydrostatic, 3-speed travel system with automatic shift and planetary gear type final drives, and hydraulic travel and parking brakes	●
PPC control levers and pedals for steering and travel	●

UNDERCARRIAGE

Track roller guards	●
Track frame under-guards	●
500, 600, 700, 800, 900 mm triple grouser shoes	○
Full length track roller guards	○

CABIN

Reinforced safety SpaceCab™; highly pressurised and tightly sealed hyper viscous mounted cab with tinted safety glass windows, large roof window with sun shade, pull-up type front window with locking device, removable lower window, front window wiper with intermittent feature, sun roller blind, cigarette lighter, ashtray, luggage shelf, floor mat	●
Heated, high-back air-suspended seat with lumbar support, console mounted height adjustable arm rests, and retractable seat belt	●
Automatic climate control system	●
12/24 Volt power supplies	●
Beverage holder and magazine rack	●
Hot and cool box	●
Radio	●
Auxiliary input (MP3 jack)	●
Lower wiper	○
Rain visor (not with OPG)	○

SERVICE AND MAINTENANCE

Automatic fuel line de-aeration	●
Double element type air cleaner with dust indicator and auto dust evacuator	●
KOMTRAX – Komatsu wireless monitoring system (3G)	●
Komatsu CARE™ – a maintenance program for Komatsu customers	●
Multifunction video compatible colour monitor with Equipment Management and Monitoring System (EMMS) and efficiency guidance	●
Toolkit	●
Service points	○
Automatic greasing system	○

WORK EQUIPMENT

Mono boom	○
Two-piece boom	○
Bucket linkage with lifting eye	○
2,4 m; 2,9 m arms	○
Komatsu buckets	○
Komatsu breakers	○

SAFETY EQUIPMENT

KomVision surround view system	●
Electric horn	●
Overload warning device	●
Audible travel alarm	●
Boom safety valves	●
Large handrails, rear-view mirrors	●
Battery main switch	●
ROPS compliant to ISO 12117-2:2008	●
Emergency engine stop switch	●
Seat belt caution indicator	●
Neutral position detection system	●
Arm safety valve	●
OPG Level II front guard (FOPS), hinged type	○
OPG Level II top guard (FOPS)	○

LIGHTING SYSTEM

Working lights: 2 revolving frame, 1 boom (l.h.)	●
Additional working lights: 4 cab roof (front), 1 cab roof (rear), 1 boom (r.h.), 1 counterweight (rear), beacon	○
LED working lights: 2 revolving frame (halogen), 2 boom (LED, l.h. & r.h.), 2 boom cylinders (LED), 4 cab roof (LED, front), 1 cab roof (halogen, rear), 2 counterweight (halogen, rear), 1 right side machine (halogen), beacon	○

OTHER EQUIPMENT

Standard counterweight	●
Remote greasing for swing circle and pins	●
Electric refuelling pump with automatic shut-off function	●
Biodegradable oil for hydraulic system	○
Customised paint	○

Further equipment on request

- standard equipment
- optional equipment

KOMATSU

**Komatsu Europe
International N.V.**

Mechelsesteenweg 586
B-1800 VILVOORDE (BELGIUM)
Tel. +32-2-255 24 11
Fax +32-2-252 19 81
www.komatsu.eu