

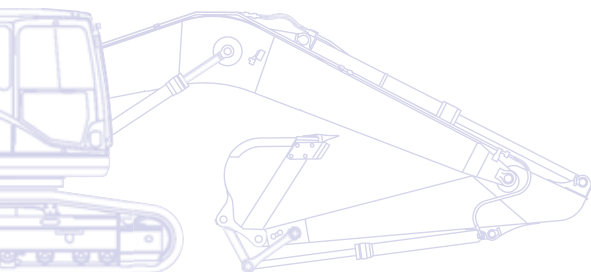

Hydraulic Excavator  
**PC360LC/NLC-10**



**ENGINE POWER**

202 kW / 271 HP @ 1.950 rpm

**OPERATING WEIGHT**

PC360LC-10: 34.620 - 35.570 kg

PC360NLC-10: 34.510 - 35.270 kg

**BUCKET CAPACITY**

max. 2,66 m<sup>3</sup>

# Walk-Around

Built around the EU Stage IIIB/EPA Tier 4 interim engine platform, Komatsu's latest generation of excavators continues a long tradition of uncompromising quality and total customer support, while renewing a commitment to safety and environmental protection. Increased net horsepower, lower fuel consumption and emissions, and the advanced electronic control system that manages airflow rate, fuel injection and combustion parameters to optimize performance and further reduce particulate matter and nitrogen oxides in the exhaust: you can trust "Dash 10" machines to keep their promises of excellence.

## Powerful and environmentally friendly

- Low consumption EU Stage IIIB/EPA Tier 4 interim engine
- Fuel-saving engine and hydraulic technology
- Adjustable Eco-gauge and idle caution
- Reduced wastage

## Total versatility

- Ideal for a wide range of applications
- 6 working modes
- Two-mode boom control
- Wide choice of options
- Built-in versatility



# PC360-10

## ENGINE POWER

202 kW / 271 HP @ 1.950 rpm

## OPERATING WEIGHT

PC360LC-10: 34.620 - 35.570 kg

PC360NLC-10: 34.510 - 35.270 kg

## BUCKET CAPACITY

max. 2,66 m<sup>3</sup>



## First-class operator comfort

- Fully air suspended operator station
- Low noise design
- Low vibration levels
- Large, widescreen hi-res display monitor
- Improved operator convenience



## Highest safety standards

- Safe SpaceCab™  
ROPS compliant with ISO 12117-2:2008
- Low profile rear view camera
- Optimal jobsite safety
- Safe access, easy maintenance
- Falling Object Protection System (FOPS) optional

**KOMTRAX**

Komatsu Wireless  
Monitoring System

## Quality you can rely on

- Reliable and efficient
- Rugged design
- Komatsu-quality components
- Extensive dealer support network

# Total Versatility

## Ideal for a wide range of applications

Powerful and precise, the Komatsu PC360-10 is equipped to efficiently carry out any task your business requires. On big sites or small, for digging, trenching, landscaping or site preparation, the Komatsu original equipment hydraulic system always ensures maximum productivity and control.

## 6 working modes

Power, Lifting, Breaker, Economy, Attachment Power and Attachment Economy modes are all available, ensuring that the PC360-10 delivers the power you need with minimised fuel usage. The Economy mode can be adjusted for an ideal balance between power and economy to match your work. The oil flow delivered to hydraulic attachments is adjustable directly on the class-leading wide screen monitor panel.

## Built-in versatility

An additional hydraulic circuit (optional), controlled by a sliding joystick push button and a floor mounted pedal, gives the PC360-10 excellent versatility. Ten attachment memory settings are provided, with individually definable names. In combination with the standard-fit hydraulic quick coupler power circuit, changing working style is now even simpler. A second auxiliary hydraulic line is available for attachments which require extra hydraulic actuation.

## A wide choice of options

With a choice of arms and undercarriages, you can configure the PC360-10 to match specific demands for transport, working envelope or duty. Extra hydraulic arrangements are available for almost every boom and arm configuration, making sure that the machine always contributes strongly to your business.

## Two-mode boom control

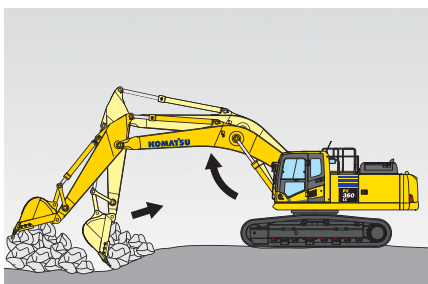

*Smooth mode*  
Boom floats upward, reducing lifting of machine front. This facilitates gathering blasted rock and scraping down operations.

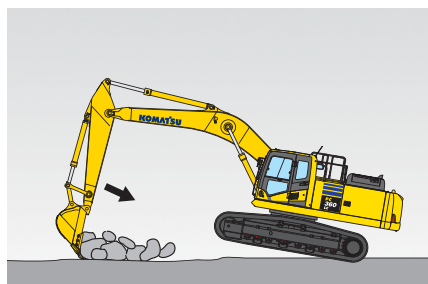

*Power mode*  
Boom pushing force is increased, ditch digging and box digging operation on hard ground are improved.





# Powerful and Environmentally Friendly

## New Komatsu engine technology

The powerful and fuel-efficient Komatsu SAA6D114E-5 engine in the PC360-10 delivers 202 kW/271 HP and is EU Stage IIIB/EPA Tier 4 interim certified. To maximise power, fuel efficiency and emission compliance, it is turbo charged and features direct fuel injection, air-to-air after cooling and cooled EGR.

## Fuel-saving engine and hydraulic technology

The PC360-10 features variable speed matching of the engine and hydraulic pump, and an automatic low idle. The new engine and pump control technology lower total fuel consumption and guarantee efficiency and precision during single and combined movements.

## Adjustable Eco-gauge and idle caution

The new Eco-gauge can be set to target a fuel consumption value, encouraging the operator to work as efficiently as possible. And to further avoid wasting fuel when the machine is not actually working, a standard-fit idle caution is displayed if the engine idles for 5 minutes or more.

### **Komatsu Diesel Particulate Filter (KDPF)**

Komatsu's high efficiency DPF captures more than 90% of particulate matter. It includes a special oxidation catalyst with fuel injection system that can incinerate trapped particulates by either active or passive regeneration with no need to interrupt machine operations.

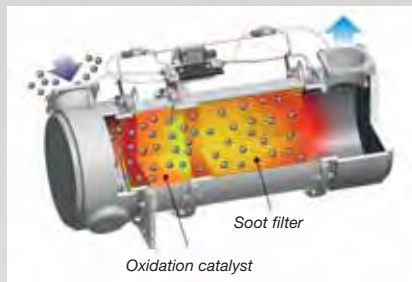

### **Exhaust Gas Recirculation (EGR)**

Cooled EGR is a technology well-proven in current Komatsu engines. The increased capacity of the EGR cooler now ensures very low NOx emissions and a better engine performance.

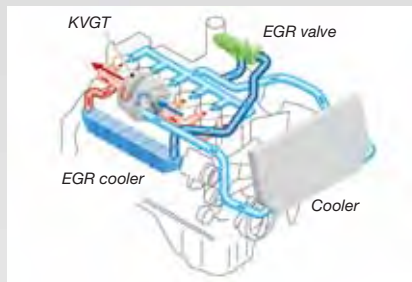

### **Komatsu Variable Geometry Turbo (KVGT)**

The KVGT provides optimal air flow to the engine combustion chamber under all speed and load conditions. Exhaust gas is cleaner, fuel economy is improved while machine power and performance are maintained.

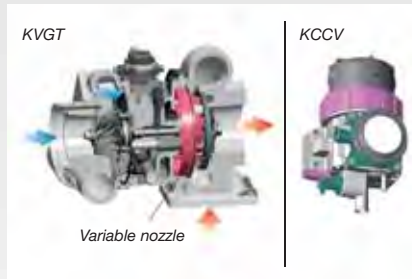

### **Komatsu Closed Crankcase Ventilation (KCCV)**

Crankcase emissions (blow-by gas) are passed through a CCV filter. The oil mist trapped in the filter is returned back to the crankcase while the filtered gas is returned to the air intake.

### **High-Pressure Common Rail (HPCR)**

To achieve complete fuel burn and lower exhaust emissions, the heavy duty High-Pressure Common Rail fuel injection system is computer controlled to deliver a precise quantity of pressurised fuel into the redesigned engine combustion chamber by multiple injections.

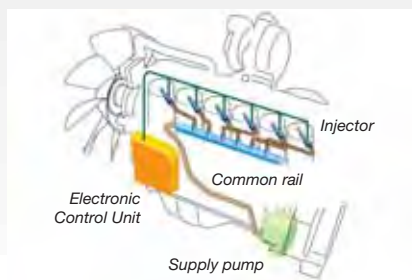



## Reduced wastage

Standard equipment on all PC360-10 includes an electric fuel pump, simple to operate and with an automatic shut-off. To further increase the system's safety, a barrier and special foams help to avoid any spilt fuel flowing towards hot areas of the machine.



# First-Class Operator Comfort

## Newly designed, spacious cab

The wide spacious cab features a new, fully air suspended operator control station that incorporates the side consoles mounted together with a high back, fully adjustable seat, heated for improved comfort.

## Improved operator convenience

With increased in-cab storage space, an auxiliary input (MP3 jack) and 12 V and 24 V power supply, the cab offers maximum convenience. The automatic air conditioner allows the operator to easily and precisely set the cab's atmosphere.

## Low noise design

Komatsu Dash 10 crawler excavators have very low external noise levels and are especially well-suited for work in confined spaces or urban areas. Reduced fan speed, a large capacity radiator, and the optimal usage of sound insulation and of sound absorbing materials help to make noise levels inside Dash 10 excavators comparable to those inside an executive car.

## Cab damper mounting

The built-in stability of the Komatsu PC360-10, combined with a highly rigid deck and a sprung multi-layer viscous mount system, drastically reduces vibration levels for the operator.



Automatic air conditioner



Hot and cool box



Joysticks with proportional control button for attachments





## Large, widescreen hi-res display monitor

To enable safe, accurate and smooth work, the user friendly monitor is the highly intuitive user interface for the machine's Equipment Management and Monitoring System (EMMS). Easily customized and with a choice of 25 languages, it features simple switches and multifunction keys that provide the operator with fingertip access to a wide range of functions and operating information.



# Highest Safety Standards

## Safe SpaceCab™

The new cab is ROPS compliant with ISO 12117-2:2008. It has a tubular steel frame and provides very high shock absorbency, impact resistance and durability. The seat belt is designed to keep the operator in the safety zone of the cab in the event of a roll-over. Optionally it can be fitted with an ISO 10262 Level 2 Falling Object Protective System (FOPS) with openable front guard.

## Safe and easy maintenance

Thermal guards are placed around high temperature parts of the engine. The fan belt and pulleys are well protected and in case of damage, fire risk is reduced by a pump/engine partition that prevents hydraulic oil from spraying onto the engine. The engine hood is hinged to the rear, with anti-slip plates positioned around the engine bay to ensure safe and easy access from all sides. Exceptionally sturdy handrails further contribute to a high safety level.



Safe SpaceCab™

## Optimal job site safety

Safety features on the Komatsu PC360-10 comply with the latest industry standards and work together as a system to minimise risks to personnel in and around the machine. An audible travel alarm further promotes job site safety. Highly durable anti-slip plates – with additional high friction covering – maintain long term traction performance.

## Rear view camera

A standard fitment camera gives an exceptionally clear view of the rear work zone on the wide-screen monitor panel. The low profile camera is adjustable and integrated into the counterweight's shape. On request, another camera can be added to the right side of the machine.



Low profile rear view camera



Large handrails

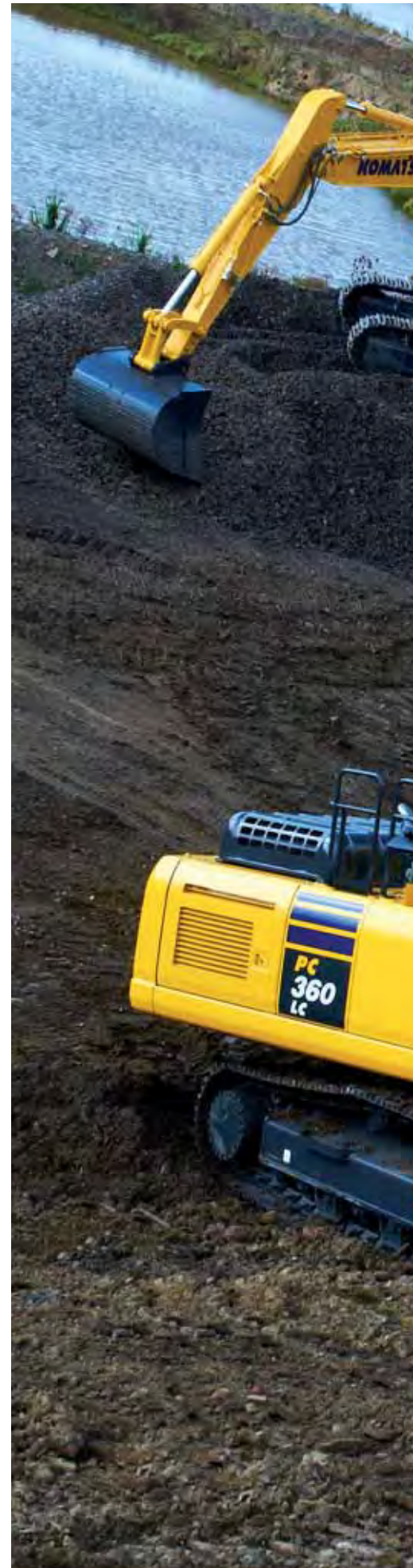



# Quality You Can Rely On

## Reliable and efficient

Productivity is the key to success – all major components of the PC360-10 are designed and directly manufactured by Komatsu. Essential machine functions are perfectly matched for a highly reliable and productive machine.

## Rugged design

Maximum toughness and durability – along with top class customer service – are the cornerstones of Komatsu's philosophy. Single piece plates and castings are used in key areas of the machine's structure for good load distribution. Highly durable rubbing strips on the underside of the arm protect the structure from material falling from the bucket.

## Komatsu-quality components

With the latest computer design techniques and a thorough test programme, Komatsu's global know-how produces machines that are designed, manufactured and tested to meet your highest standards.

## Extensive dealer support network

The extensive Komatsu distribution and dealer network is standing by to help keep your fleet in optimum condition. Customised servicing packages are available, with express availability of spare parts, to make sure that your Komatsu will continue to perform at its peak.

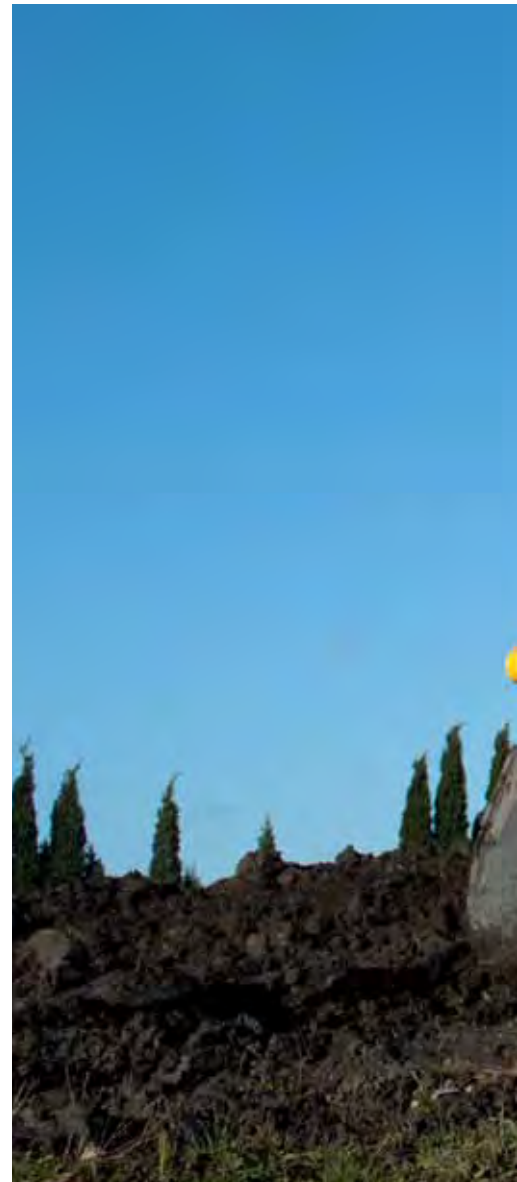

Cast boom foot



Single piece boom plates



# Komatsu Wireless Monitoring System

## The easy way to higher productivity

KOMTRAX™ is the latest in wireless monitoring technology. It delivers insightful and cost saving information about your fleet and equipment and offers you a wealth of information to facilitate peak machine performance. By creating a tightly integrated web of support it allows pro active and preventive maintenance and helps you to efficiently run a business.

## Knowledge

You get quick answers to basic and critical questions about your machines - what they're doing, when they did it, where they're located, how they can be used more efficiently, and when they need to be serviced. Performance data is relayed by satellite from your machine to your computer and to your local Komatsu distributor - who's readily available for expert analysis and feedback.

## Convenience

KOMTRAX™ helps to conveniently manage your fleet on the web, wherever you are. Data is analysed and packaged specifically for easy and intuitive viewing in maps, lists, graphs and charts. You can anticipate the type of service and parts your machines could require, or troubleshoot problems before Komatsu technicians arrive on site.



## Power

The detailed information that KOMTRAX™ puts at your fingertips 24 hours a day, 7 days a week gives you the power to make better daily and long-term strategic decisions. You can anticipate problems, customize maintenance schedules, minimize downtime and keep your machines where they belong – working on the job site.



Through the web application, a variety of search parameters are available to quickly find information about specific machines based on key factors such as utilization rates, age, various notification messages, and more.

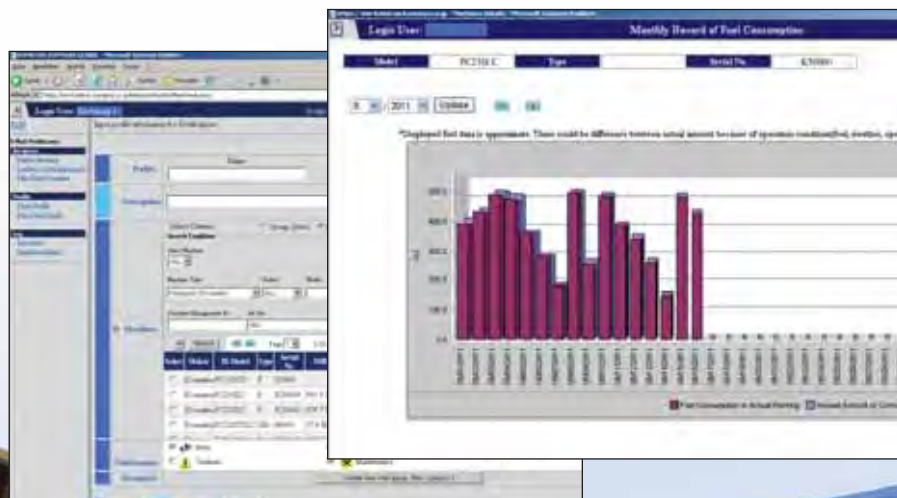

A simple chart shows the machine's fuel consumption and helps you to calculate total costs for a job site and conveniently schedule fuel deliveries.

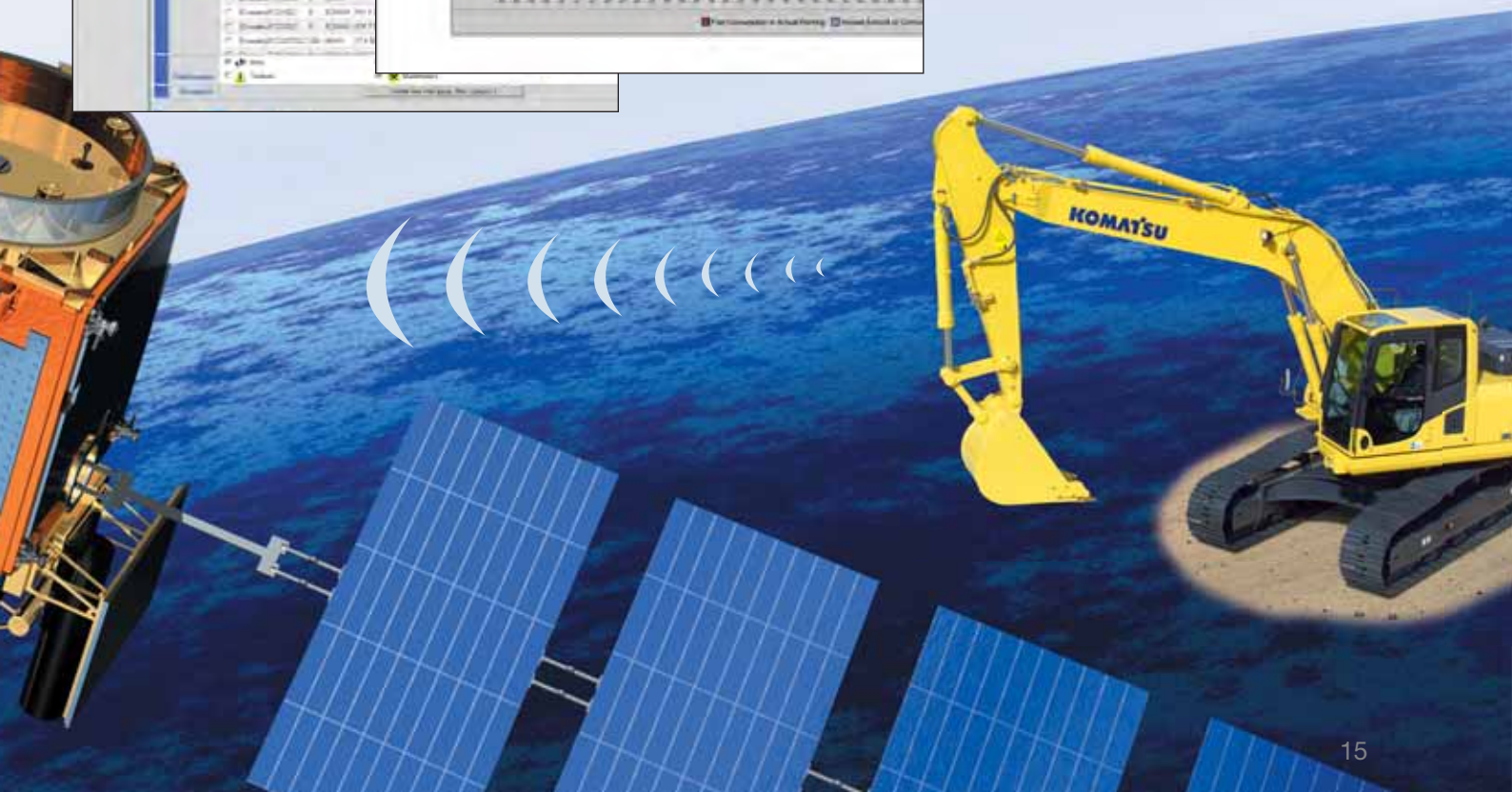

# Easy Maintenance

## Easy cleaning of coolers

Hinged air conditioning cooler and side-by-side radiator and oil cooler allow easy access for cleaning.



## Quick access to filters and fuel drain valve

The engine oil filter, the fuel filters and the fuel drain valve are mounted remotely to make them accessible from ground level.



## Diesel particulate filter regeneration

Soot trapped in the diesel particulate filter is periodically and automatically oxidized using the heat from the engine exhaust.



## Water separator

This is standard equipment which removes any water that has become mixed with the fuel, preventing fuel system damage.



## Washable floor

The floor is easy to keep clean. The gently inclined surface has a flanged floormat and drainage holes to facilitate runoff.

## Inclined track frame

The track frame is sloped so that dirt will not accumulate and can be removed easily.

## Long-life oil filters

The hydraulic oil filter uses high-performance filtering material for long element replacement intervals, which significantly reduces maintenance costs.



## Flexible warranty

When you purchase Komatsu equipment, you gain access to a broad range of programmes and services that have been designed to help you get the most from your investment. For example, Komatsu's Flexible Warranty Programme provides a range of extended warranty options on the machine and its components. These can be chosen to meet your individual needs and activities. This programme is designed to help reduce total operating costs.





## ENGINE

Model .....	Komatsu SAA6D114E-5
Type .....	Common rail direct injection, water-cooled, emissionised, turbocharged, after-cooled diesel
Engine power	
at rated engine speed .....	1.950 rpm
ISO 14396 .....	202 kW/271 HP
ISO 9249 (net engine power) .....	192 kW/257 HP
No. of cylinders .....	6
Bore x stroke .....	114 x 144,5 mm
Displacement .....	8,85 ltr
Battery .....	2 x 12 V/155 Ah
Alternator .....	24 V/60 A
Starter motor .....	24 V/11 kW
Air filter type .....	Double element type with monitor panel dust indicator and auto dust evacuator
Cooling .....	Suction type cooling fan with radiator fly screen

## HYDRAULIC SYSTEM

Type .....	HydrauMind. Closed-centre system with load sensing and pressure compensation valves
Additional circuits .....	2 additional circuits with proportional control can be installed
Main pump .....	2 variable displacement piston pumps supplying boom, arm, bucket, swing and travel circuits
Maximum pump flow .....	2 x 267,5 ltr/min
Relief valve settings	
Implement .....	380 kg/cm <sup>2</sup>
Travel .....	380 kg/cm <sup>2</sup>
Swing .....	295 kg/cm <sup>2</sup>
Pilot circuit .....	33 kg/cm <sup>2</sup>

## UNDERCARRIAGE

Construction .....	X-frame centre section with box section track frames
Track assembly	
Type .....	Fully sealed
Shoes (each side) .....	48
Tension .....	Combined spring and hydraulic unit
Rollers	
Track rollers (each side) .....	8
Carrier rollers (each side) .....	2

## OPERATING WEIGHT (APPR.)

	PC360LC-10		PC360NLC-10	
	Operating weight	Ground pressure	Operating weight	Ground pressure
Triple grouser shoes				
600 mm	34.620 kg	0,66 kg/cm <sup>2</sup>	34.510 kg	0,66 kg/cm <sup>2</sup>
700 mm	35.000 kg	0,57 kg/cm <sup>2</sup>	34.890 kg	0,57 kg/cm <sup>2</sup>
800 mm	35.380 kg	0,51 kg/cm <sup>2</sup>	35.270 kg	0,51 kg/cm <sup>2</sup>
850 mm	35.570 kg	0,48 kg/cm <sup>2</sup>	-	-

Operating weight, including specified work equipment, 3,2 m arm, 1.015 kg bucket, operator, lubricant, coolant, full fuel tank and the standard equipment.

## SWING SYSTEM

Type .....	Axial piston motor driving through planetary double reduction gearbox
Swing lock .....	Electrically actuated wet multi-disc brake integrated into swing motor
Swing speed .....	0 - 9,5 rpm
Swing torque .....	102,9 kNm

## DRIVES AND BRAKES

Steering control .....	2 levers with pedals giving full independent control of each track
Drive method .....	Hydrostatic
Travel operation .....	Automatic 3-speed selection
Gradeability .....	70%, 35°
Max. travel speeds	
Lo / Mi / Hi .....	3,2 / 4,5 / 5,5 km/h
Maximum drawbar pull .....	29.570 kg
Brake system .....	Hydraulically operated discs in each travel motor

## SERVICE REFILL CAPACITIES

Fuel tank .....	605 ltr
Radiator .....	37,0 ltr
Engine oil .....	35,0 ltr
Swing drive .....	13,7 ltr
Hydraulic tank .....	188 ltr
Final drive (each side) .....	9,0 ltr

## ENVIRONMENT

Engine emissions .....	Fully complies with EU Stage IIIB and EPA Tier 4 interim exhaust emission regulations
Noise levels	
LwA external .....	105 dB(A) (2000/14/EC Stage II)
LpA operator ear .....	71 dB(A) (ISO 6396 dynamic test)
Vibration levels (EN 12096:1997)*	
Hand/arm .....	≤ 2,5 m/s <sup>2</sup> (uncertainty K = 0,37 m/s <sup>2</sup> )
Body .....	≤ 0,5 m/s <sup>2</sup> (uncertainty K = 0,17 m/s <sup>2</sup> )

\* for the purpose of risk assessment under directive 2002/44/EC, please refer to ISO/TR 25398:2006.

# Dimensions & Performance Figures

MACHINE DIMENSIONS	PC360LC-10	PC360NLC-10
A Overall width of upper structure	3.145 mm	3.145 mm
B Overall height of cab	3.160 mm	3.160 mm
C Overall length of basic machine	5.885 mm	5.885 mm
D Tail length	3.405 mm	3.405 mm
Tail swing radius	3.445 mm	3.445 mm
E Clearance under counterweight	1.185 mm	1.185 mm
F Machine tail height	2.360 mm	2.360 mm
F' Machine tail height (top of engine cover)	2.750 mm	2.750 mm
G Ground clearance	500 mm	500 mm
H Tumbler centre distance	4.030 mm	4.030 mm
I Track length	4.955 mm	4.955 mm
J Track gauge	2.590 mm	2.390 mm
K Track shoe width	600, 700, 800, 850 mm	600, 700, 800 mm
L Overall track width with 600 mm shoes	3.190 mm	2.990 mm
Overall track width with 700 mm shoes	3.290 mm	3.090 mm
Overall track width with 800 mm shoes	3.390 mm	3.190 mm
Overall track width with 850 mm shoes	3.440 mm	-

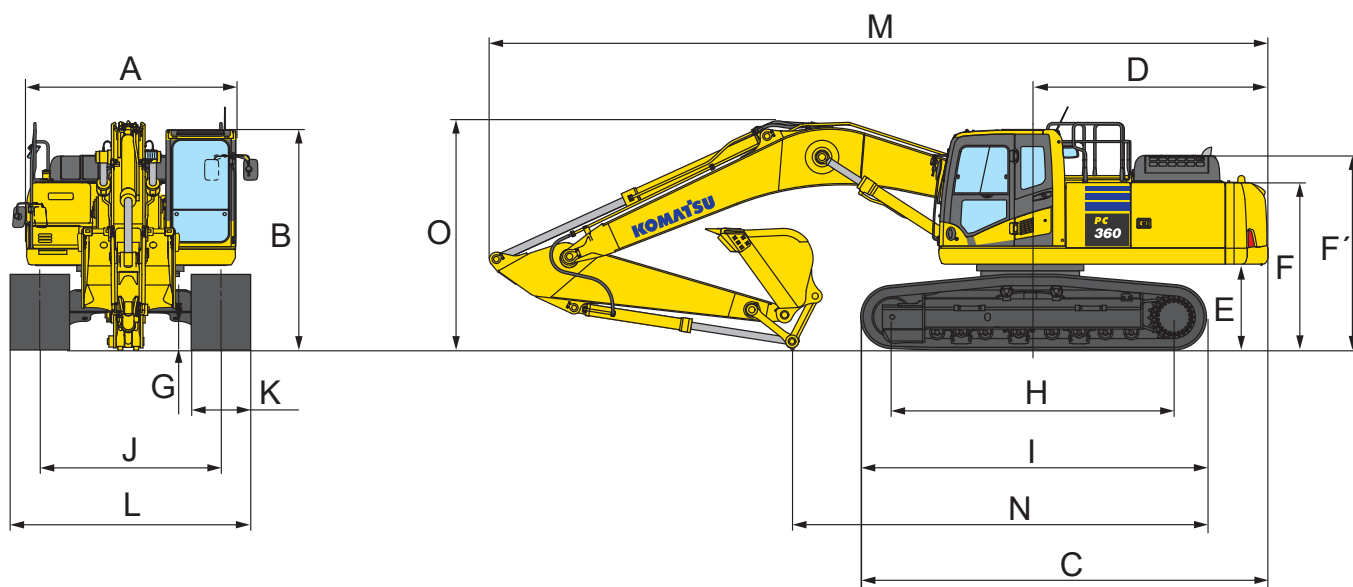

TRANSPORT DIMENSIONS	MONO BOOM			
Arm length	2,2 m	2,6 m	3,2 m	4,0 m
M Transport length	11.290 mm	11.180 mm	11.140 mm	11.170 mm
N Length on ground (transport)	7.155 mm	6.760 mm	5.930 mm	5.475 mm
O Overall height (to top of boom)	3.400 mm	3.410 mm	3.280 mm	3.760 mm

**PC360LC-10 / MAX. BUCKET CAPACITY AND WEIGHT**

<b>MONO BOOM</b>								
Arm length	2,2 m		2,6 m		3,2 m		4,0 m	
Material weight up to 1,2 t/m <sup>3</sup>	2,66 m <sup>3</sup>	1.650 kg	2,66 m <sup>3</sup>	1.650 kg	2,66 m <sup>3</sup>	1.650 kg	2,02 m <sup>3</sup>	1.400 kg
Material weight up to 1,5 t/m <sup>3</sup>	2,66 m <sup>3</sup>	1.650 kg	2,55 m <sup>3</sup>	1.625 kg	2,29 m <sup>3</sup>	1.500 kg	1,87 m <sup>3</sup>	1.350 kg
Material weight up to 1,8 t/m <sup>3</sup>	2,36 m <sup>3</sup>	1.525 kg	2,21 m <sup>3</sup>	1.475 kg	1,90 m <sup>3</sup>	1.375 kg	1,13 m <sup>3</sup>	1.000 kg

**PC360NLC-10 / MAX. BUCKET CAPACITY AND WEIGHT**

<b>MONO BOOM</b>								
Arm length	2,2 m		2,6 m		3,2 m		4,0 m	
Material weight up to 1,2 t/m <sup>3</sup>	2,66 m <sup>3</sup>	1.650 kg	2,66 m <sup>3</sup>	1.650 kg	2,47 m <sup>3</sup>	1.575 kg	2,02 m <sup>3</sup>	1.400 kg
Material weight up to 1,5 t/m <sup>3</sup>	2,50 m <sup>3</sup>	1.600 kg	2,32 m <sup>3</sup>	1.525 kg	2,08 m <sup>3</sup>	1.425 kg	1,82 m <sup>3</sup>	1.300 kg
Material weight up to 1,8 t/m <sup>3</sup>	2,16 m <sup>3</sup>	1.450 kg	2,00 m <sup>3</sup>	1.375 kg	1,80 m <sup>3</sup>	1.300 kg	1,13 m <sup>3</sup>	1.000 kg

Max. capacity and weight have been calculated according to ISO 10567:2007.

Please consult with your distributor for the correct selection of buckets and attachments to suit the application.

**BUCKET AND ARM FORCE**

Arm length	2,2 m	2,6 m	3,2 m	4,0 m
Bucket digging force	24.700 kg	24.700 kg	21.600 kg	21.600 kg
Bucket digging force at PowerMax	26.400 kg	26.400 kg	23.100 kg	23.100 kg
Arm crowd force	22.400 kg	19.100 kg	16.300 kg	13.700 kg
Arm crowd force at PowerMax	24.000 kg	20.500 kg	17.400 kg	14.700 kg

# Working Range

## MONO BOOM

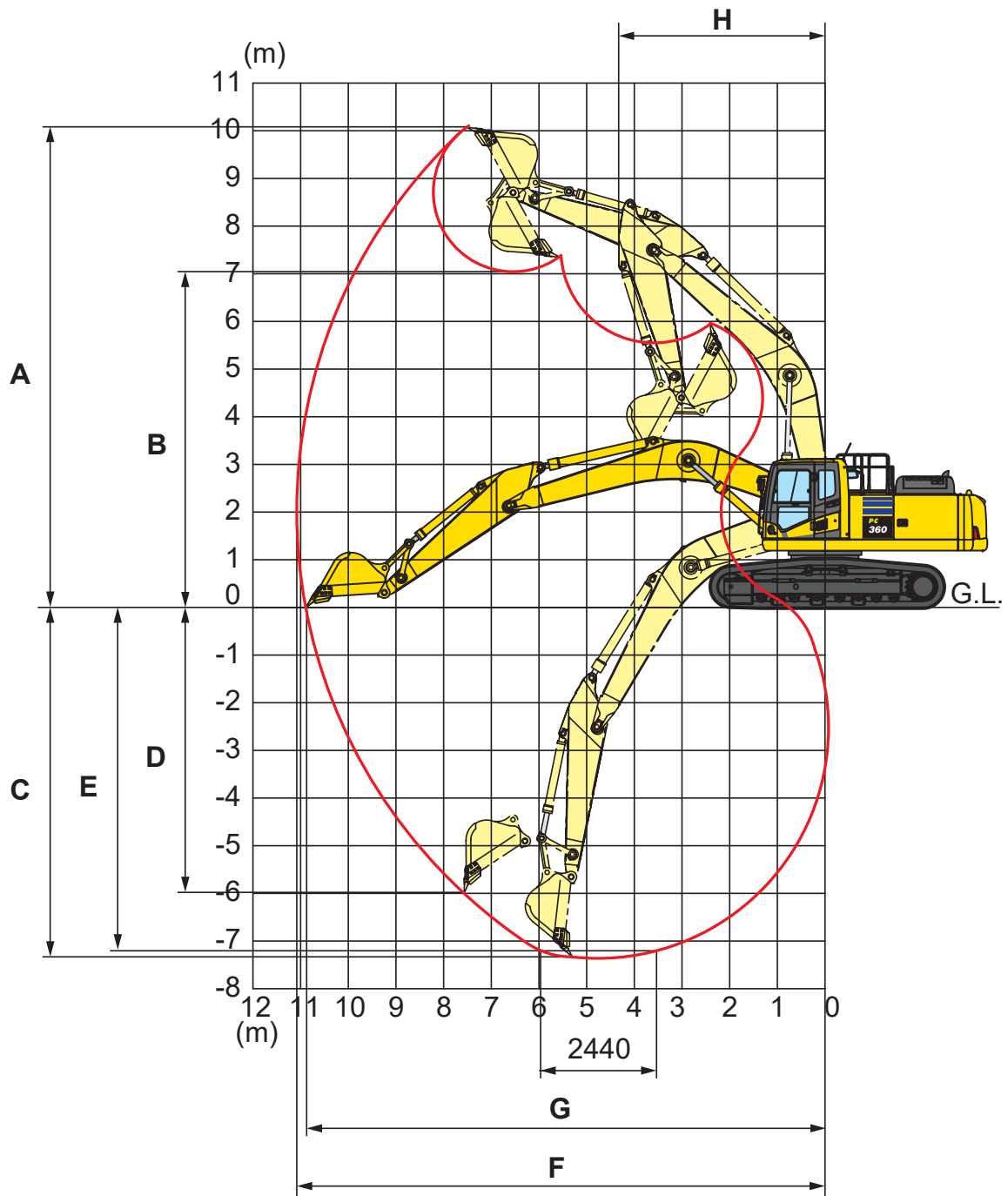













ARM LENGTH	2,2 m	2,6 m	3,2 m	4,0 m
A Max. digging height	9.580 mm	9.965 mm	10.210 mm	10.550 mm
B Max. dumping height	6.595 mm	6.895 mm	7.110 mm	7.490 mm
C Max. digging depth	6.355 mm	6.705 mm	7.380 mm	8.180 mm
D Max. vertical wall digging depth	5.120 mm	5.880 mm	6.480 mm	7.280 mm
E Max. digging depth of cut for 2,44 m level	6.130 mm	6.520 mm	7.180 mm	8.045 mm
F Max. digging reach	10.155 mm	10.550 mm	11.100 mm	11.900 mm
G Max. digging reach at ground level	9.950 mm	10.355 mm	10.920 mm	11.730 mm
H Min. swing radius	4.390 mm	4.400 mm	4.310 mm	4.320 mm



# Lifting Capacity

## PC360LC-10 MONO BOOM

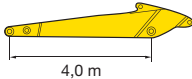
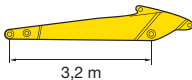
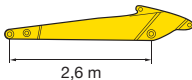
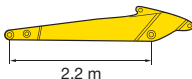
Arm length	A		↔		9,0 m		7,5 m		6,0 m		4,5 m		3,0 m	
	B													
	6,0 m	kg	*5.470	5.440	*7.220	5.870	*7.960	7.850						
	4,5 m	kg	*5.490	4.930	*7.870	5.770	*8.560	7.610						
	3,0 m	kg	*5.660	4.650	*8.250	5.610	*9.340	7.300	*11.130	10.030	*14.560	*14.560		
	1,5 m	kg	*5.970	4.540	8.200	5.440	*10.080	7.000	*12.480	9.470	*17.080	14.080		
	0,0 m	kg	*6.490	4.590	8.040	5.300	10.390	6.750	*13.330	9.060	*18.230	13.430	*8.100	*8.100
	-1,5 m	kg	7.320	4.830	7.960	5.230	10.220	6.600	*13.500	8.830	*18.100	13.180	*12.160	*12.160
	-3,0 m	kg	*7.960	5.330			*10.130	6.560	*12.870	8.780	*16.900	13.190	*17.440	*17.440
	-4,5 m	kg	*7.780	6.350			*8.470	6.690	*11.210	8.900	*14.530	13.400	*19.380	*19.380
	-6,0 m	kg	*6.950	*6.950					*7.520	*7.520	*10.320	*10.320	*13.110	*13.110
		6,0 m	kg	*6.960	6.240			*8.760	7.640					
4,5 m		kg	*7.030	5.570	*7.650	5.640	*9.270	7.440	*10.700	10.320				
3,0 m		kg	*7.310	5.220	8.280	5.530	*9.950	7.180	*12.060	9.800	*16.280	14.670		
1,5 m		kg	7.660	5.090	8.150	5.410	*10.530	6.930	*13.170	9.330	*18.170	13.790		
0,0 m		kg	7.830	5.180	8.050	5.320	10.370	6.740	*13.660	9.040	*18.460	13.420		
-1,5 m		kg	8.390	5.520			10.280	6.660	*13.400	8.920	*17.600	13.360	*13.300	*13.300
-3,0 m		kg	*8.630	6.270			*9.470	6.710	*12.240	8.950	*15.750	13.480	*20.330	*20.330
-4,5 m		kg	*8.140	7.920					*9.690	9.160	*12.560	*12.560	*15.600	*15.600
-6,0 m		kg												
		6,0 m	kg	*9.390	6.960			*9.500	7.590	*10.450	*10.450			
	4,5 m	kg	9.140	6.140			*9.880	7.420	*11.530	10.220	*14.810	*14.810		
	3,0 m	kg	8.560	5.730			*10.440	7.190	*12.760	9.730	*17.560	14.340		
	1,5 m	kg	8.400	5.600			10.610	6.980	*13.640	9.330				
	0,0 m	kg	8.630	5.730			10.460	6.840	*13.820	9.110	*18.210	13.520		
	-1,5 m	kg	*9.240	6.170			*10.390	6.810	*13.200	9.060	*16.870	13.570	*12.670	*12.670
	-3,0 m	kg	*8.940	7.180					*11.560	9.160	*14.570	13.750	*17.260	*17.260
	-4,5 m	kg	*7.850	*7.850							*10.630	*10.630		
	-6,0 m	kg												
		6,0 m	kg	*9.870	7.590					*10.830	10.510			
4,5 m		kg	*9.720	6.590			*10.110	7.340	*11.850	10.090	*15.470	15.190		
3,0 m		kg	9.160	6.100			*10.590	7.120	*12.990	9.600				
1,5 m		kg	8.970	5.950			10.560	6.930	*13.720	9.230				
0,0 m		kg	9.250	6.100			10.430	6.810	*13.710	9.050	*17.640	13.470		
-1,5 m		kg	*9.740	6.640			*10.070	6.820	*12.880	9.040	*16.140	13.560		
-3,0 m		kg	*9.380	7.910					*10.940	9.190	*13.650	*13.650	*15.120	*15.120
-4,5 m		kg	*7.880	*7.880							*9.210	*9.210		
-6,0 m		kg												

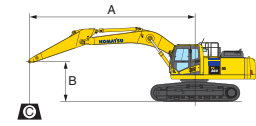

A – Reach from swing center  
 B – Bucket hook height  
 C – Lifting capacities



With 700 mm shoes

Weights:  
 With 2,2 and 2,6 m arm: bucket linkage and bucket cylinder: 470 kg  
 With 3,2 and 4,0 m arm: bucket linkage and bucket cylinder: 435 kg

\* Load is limited by hydraulic capacity rather than tipping. Ratings are based on SAE Standard No. J1097. Rated loads do not exceed 87% of hydraulic lift capacity or 75% of tipping load.

Lifting capacity stated is based on lifting with bare arm. When lifting with additional equipment installed to the arm, please subtract the weight of all additional equipment from the values stated.

## PC360NLC-10 MONO BOOM

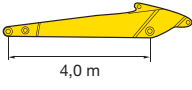
Arm length	A		↔		9,0 m		7,5 m		6,0 m		4,5 m		3,0 m	
	B													
 4,0 m	6,0 m	kg	*5.470	5.000	*7.220	5.400	*7.960	7.240						
	4,5 m	kg	*5.490	4.530	*7.870	5.300	*8.560	7.010						
	3,0 m	kg	*5.660	4.260	*8.250	5.150	*9.340	6.700	*11.130	9.180	*14.560	13.810		
	1,5 m	kg	*5.970	4.160	8.080	4.980	*10.080	6.400	*12.480	8.630	*17.080	12.710		
	0,0 m	kg	*6.490	4.200	7.930	4.840	10.240	6.160	*13.330	8.230	*18.230	12.080	*8.100	*8.100
	-1,5 m	kg	7.210	4.410	7.850	4.770	10.070	6.010	*13.500	8.010	*18.100	11.830	*12.160	*12.160
	-3,0 m	kg	*7.960	4.870			10.040	5.980	*12.870	7.960	*16.900	11.840	*17.440	*17.440
	-4,5 m	kg	*7.780	5.800			*8.470	6.100	*11.210	8.070	*14.530	12.040	*19.380	*19.380
	-6,0 m	kg	*6.950	*6.950					*7.520	*7.520	*10.320	*10.320	*13.110	*13.110

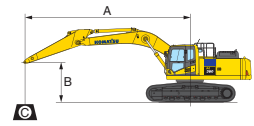

- A – Reach from swing center
- B – Bucket hook height
- C – Lifting capacities

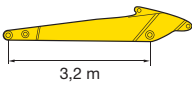
 3,2 m	6,0 m	kg	*6.960	5.740		*8.760	7.030							
	4,5 m	kg	*7.030	5.110	*7.650	5.180	*9.270	6.840	*10.700	9.470				
	3,0 m	kg	*7.310	4.780	8.170	5.070	*9.950	6.580	*12.060	8.950	*16.280	13.280		
	1,5 m	kg	7.550	4.660	8.030	4.950	10.430	6.330	*13.170	8.500	*18.170	12.430		
	0,0 m	kg	7.720	4.740	7.940	4.860	10.220	6.150	*13.660	8.210	*18.460	12.070		
	-1,5 m	kg	8.270	5.040			10.130	6.070	*13.400	8.090	*17.600	12.010	*13.300	*13.300
	-3,0 m	kg	*8.630	5.720			*9.470	6.120	*12.240	8.130	*15.750	12.120	*20.330	*20.330
	-4,5 m	kg	*8.140	7.230					*9.690	8.340	*12.560	12.420	*15.600	*15.600
	-6,0 m	kg												

- Rating over front
- Rating over side
- Rating at maximum reach

With 600 mm shoes

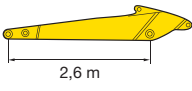
 2,6 m	6,0 m	kg	*9.390	6.410		*9.500	6.980	*10.450	9.780				
	4,5 m	kg	9.010	5.640		*9.880	6.820	*11.530	9.370	*14.810	14.090		
	3,0 m	kg	8.440	5.260		*10.440	6.600	*12.760	8.890	*17.560	12.960		
	1,5 m	kg	8.280	5.130		10.470	6.390	*13.640	8.500				
	0,0 m	kg	8.510	5.240		10.310	6.250	*13.820	8.290	*18.210	12.180		
	-1,5 m	kg	9.230	5.650		10.280	6.220	*13.200	8.240	*16.870	12.220	*12.670	*12.670
	-3,0 m	kg	*8.940	6.560				*11.560	8.330	*14.570	12.400	*17.260	*17.260
	-4,5 m	kg	*7.850	*7.850						*10.630	*10.630		
	-6,0 m	kg											

Weights:

With 2,2 and 2,6 m arm: bucket linkage and bucket cylinder: 470 kg

With 3,2 and 4,0 m arm: bucket linkage and bucket cylinder: 435 kg

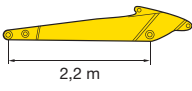
 2,2 m	6,0 m	kg	*9.870	6.980				*10.830	9.650					
	4,5 m	kg	*9.720	6.050			*10.110	6.740	*11.850	9.240	*15.470	13.790		
	3,0 m	kg	9.030	5.600			*10.590	6.530	*12.990	8.770				
	1,5 m	kg	8.840	5.450			10.410	6.340	*13.720	8.410				
	0,0 m	kg	9.120	5.580			10.280	6.220	*13.710	8.230	*17.640	12.120		
	-1,5 m	kg	*9.740	6.070			*10.070	6.230	*12.880	8.220	*16.140	12.210		
	-3,0 m	kg	*9.380	7.220					*10.940	8.360	*13.650	12.430	*15.120	*15.120
	-4,5 m	kg	*7.880	*7.880							*9.210	*9.210		
	-6,0 m	kg												

\* Load is limited by hydraulic capacity rather than tipping. Ratings are based on SAE Standard No. J1097.

Rated loads do not exceed 87% of hydraulic lift capacity or 75% of tipping load.

Lifting capacity stated is based on lifting with bare arm. When lifting with additional equipment installed to the arm, please subtract the weight of all additional equipment from the values stated.

# Hydraulic Excavator

## PC360LC/NLC-10

### Standard and Optional Equipment

#### ENGINE

Komatsu SAA6D114E-5 turbocharged common rail direct injection diesel engine	●
EU Stage IIIB/EPA Tier 4 interim compliant	●
Suction type cooling fan with radiator fly screen	●
Automatic engine warm-up system	●
Engine overheat prevention system	●
Fuel control dial	●
Auto-deceleration function	●
Engine key stop	●
Engine ignition can be password secured on request	●
Alternator 24 V/60 A	●
Starter motor 24 V/11 kW	●
Batteries 2 × 12 V/155 Ah	●

#### HYDRAULIC SYSTEM

Electronic closed-centre load sensing (E-CLSS) hydraulic system (HydrauMind)	●
Pump and engine mutual control (PEMC) system	●
6-working mode selection system; power mode, economy mode, breaker mode, attachment power and attachment economy mode, and lifting mode	●
PowerMax function	●
Adjustable PPC wrist control levers for arm, boom, bucket and swing, with sliding proportional control for attachments and 3 auxiliary buttons	●
Two-mode boom control	●
Prepared for hydraulic quick-coupler	●
Additional hydraulic functions	○

#### UNDERCARRIAGE

Track roller guards	●
Track frame under-guards	●
600, 700, 800, 850 mm triple grouser shoes	○
Full length track roller guards	○

#### CABIN

Reinforced safety SpaceCab™; highly pressurised and tightly sealed hyper viscous mounted cab with tinted safety glass windows, large roof window with sun shade, pull-up type front window with locking device, removable lower window, front window wiper with intermittent feature, sun roller blind, cigarette lighter, ashtray, luggage shelf, floor mat	●
Heated, high back air suspension seat with lumbar support, console mounted height adjustable arm rests, and retractable seat belt	●
Automatic climate control system	●
12/24 Volt power supplies	●
Beverage holder and magazine rack	●
Hot and cool box	●
Radio	●
Auxiliary input (MP3 jack)	●
Lower wiper	○
Rain visor (not with OPG)	○

#### SERVICE AND MAINTENANCE

Automatic fuel line de-aeration	●
Double element type air cleaner with dust indicator and auto dust evacuator	●
KOMTRAX™ - Komatsu wireless monitoring system	●
Multi-function video compatible colour monitor with Equipment Management and Monitoring System (EMMS) and efficiency guidance	●
Toolkit	●
Service points	○
Automatic greasing system	○

#### WORK EQUIPMENT

Mono boom	●
2,2 m; 2,6 m; 3,2 m; 4,0 m arms	○
Komatsu buckets	○
Komatsu breakers	○

#### SAFETY EQUIPMENT

Rear view camera system	●
Electric horn	●
Overload warning device	●
Audible travel alarm	●
Boom safety valves	●
Large handrails, rear-view mirrors	●
Battery main switch	●
ROPS compliant to ISO 12117-2:2008	●
Emergency engine stop switch	●
Arm safety valve	●
OPG Level II front guard (FOPS), hinged type	○
OPG Level II top guard (FOPS)	○
Additional camera, right side mounted	○

#### DRIVES AND BRAKES

Hydrostatic, 3-speed travel system with automatic shift and planetary gear type final drives, and hydraulic travel and parking brakes	●
PPC control levers and pedals for steering and travel	●

#### LIGHTING SYSTEM

Working lights: 2 revolving frame, 1 boom (l.h.)	●
Additional working lights: 4 cab roof (front), 1 cab roof (rear), 1 boom (r.h.), 1 counterweight (rear), beacon	○

#### OTHER EQUIPMENT

Standard counterweight	●
Remote greasing for swing circle and pins	●
Electric refuelling pump with automatic shut-off function	●
Biodegradable oil for hydraulic system	○
Customised paint	○

Further equipment on request

- standard equipment
- optional equipment

Your Komatsu partner:

# KOMATSU

**Komatsu Europe  
International NV**  
Mechelsesteenweg 586  
B-1800 VILVOORDE (BELGIUM)  
Tel. +32-2-255 24 11  
Fax +32-2-252 19 81  
[www.komatsu.eu](http://www.komatsu.eu)

UESS14700 01/2012

Materials and specifications are subject to change without notice.  
**KOMATSU** is a trademark of Komatsu Ltd. Japan.